



Wlanantenne 2.4 GHz IP54
Spritzwassergeschützt IP54, Best.Nr. 17014.RPSMA



Die Abdichtung zwischen der Rändelschraube und erfolgt durch einen speziellen in die Antenne integrierten Dichtring. Die Abdichtung zwischen Antennenvorderkante und RPSMA-Buchse ist vom Kunden sicherzustellen.



Dichtring / gasket

Specifications:

Frequency Range :	2.4 ~ 2.4835GHz
VSWR :	≤ 2.0
Impedance :	50Ω ± 5Ω
Gain :	3dBi
Polarization :	Vertical
Power Handling :	1 Watt
Beam Width :	H: 360° / E: 32.2°
Connector :	SMA Male, RP SMA male
Operation Temp. :	-30° ~ +60°
Material :	Radome: ABS Base: ABS
Dimension (L*W*H) :	114* Ø 13.4 mm
Weight :	22g ± 2g
Color :	Black

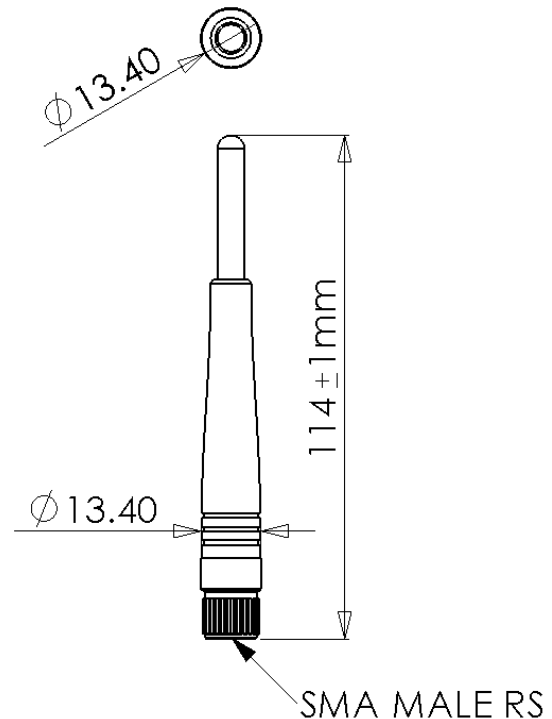

WiMo Antennen und Elektronik GmbH

Am Gäxwald 14, D-76863 Herxheim Tel. (07276) 96680 FAX 9668-11
<http://www.wimo.com> e-mail: info@wimo.com

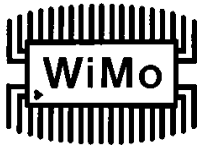

Wlanantenne 2.4 GHz IP54
Spritzwassergeschützt IP54, Best.Nr. 17014.RPSMA

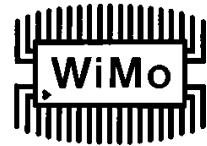

Return Loss

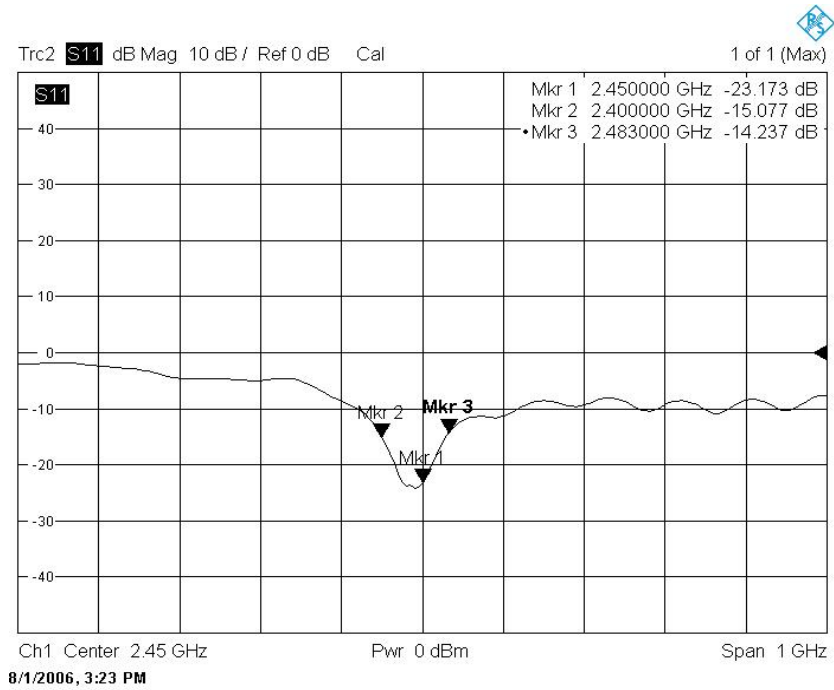

SWR

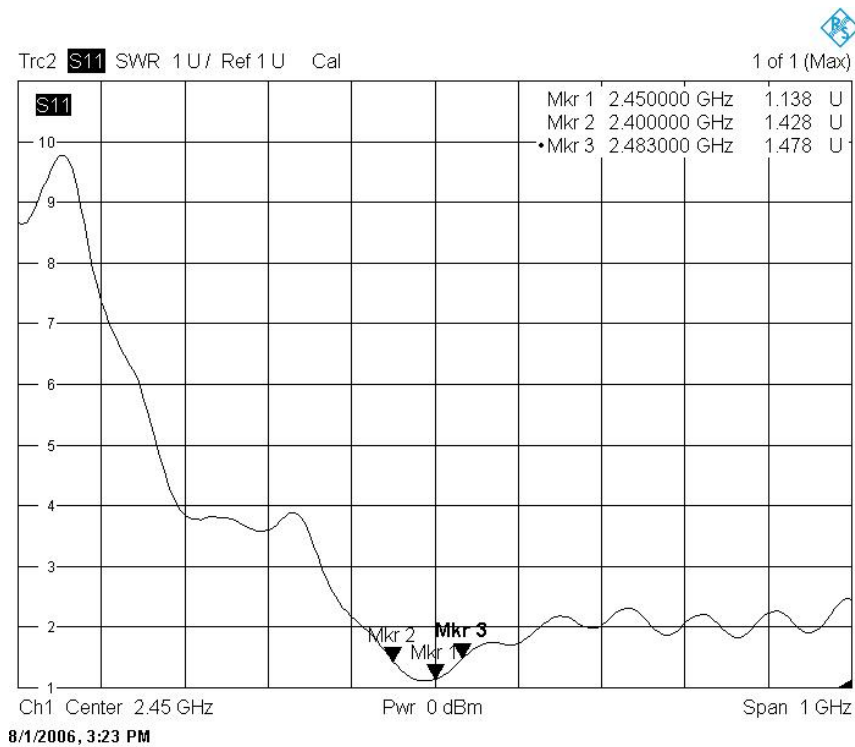

WiMo Antennen und Elektronik GmbH

Am Gäxwald 14, D-76863 Herxheim Tel. (07276) 96680 FAX 9668-11

<http://www.wimo.com>

e-mail: info@wimo.com

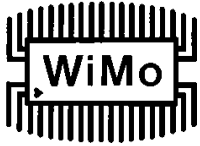

Wlanantenne 2.4 GHz IP54
Spritzwassergeschützt IP54, Best.Nr. 17014.RPSMA



H Plane

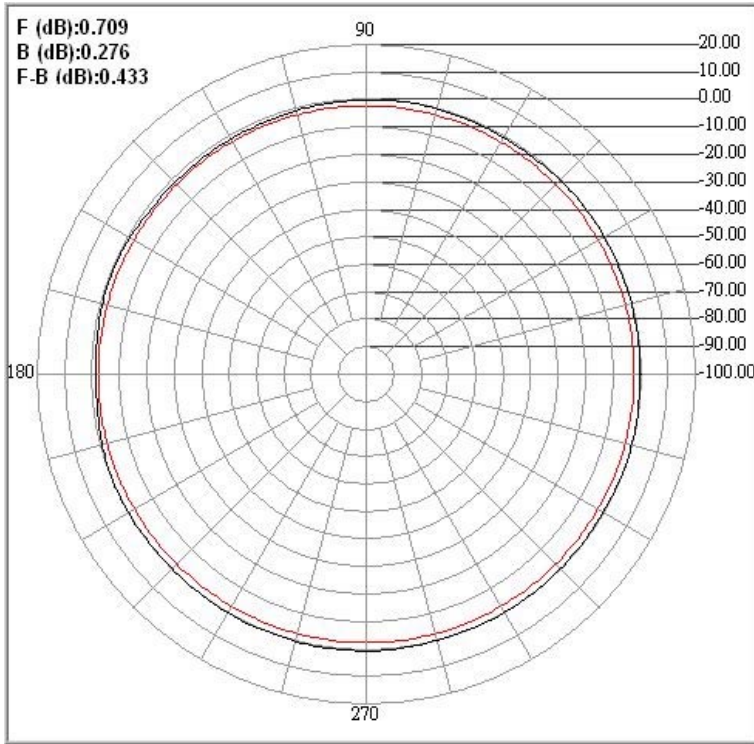

E Plane

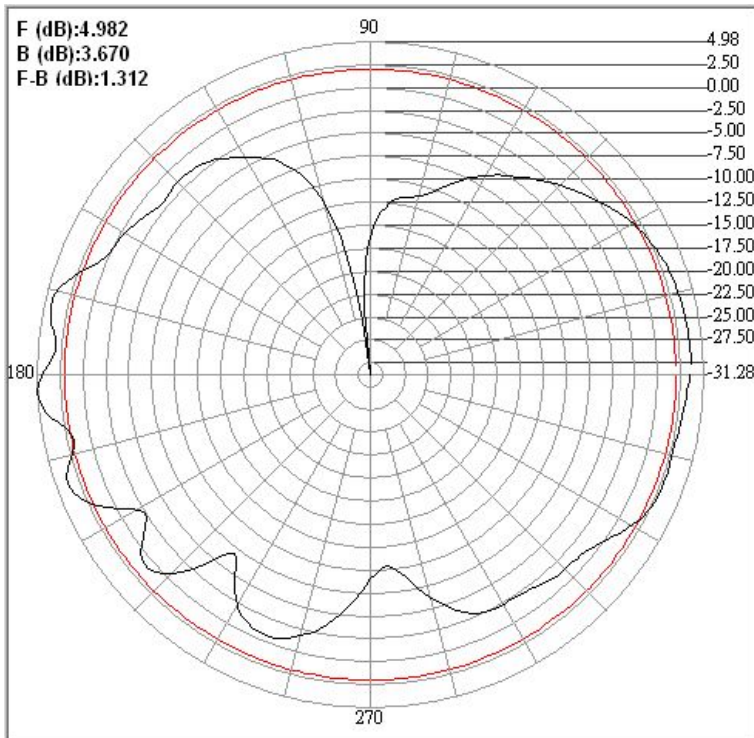

WiMo Antennen und Elektronik GmbH

Am Gäxwald 14, D-76863 Herxheim Tel. (07276) 96680 FAX 9668-11

<http://www.wimo.com>

e-mail: info@wimo.com