

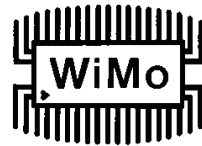

**Aufsteckantenne GSM 900/1800/1900/2100**  
Best.Nr. 60024 / 60024.RA



Kleine Quadband-Aufsteckantenne für GSM 900/1800/1900 MHz und UMTS sowie für LTE und ISM bei 800 MHz.

Small quadband antenna for GSM 900/1800/1900 MHz devices as well as UMTS/LTE G3/G4 and 868 MHz ISM.

**Specifications**

Frequency Range	850-960/1800-2170 MHz
VSWR	≤ 2:1
Impedance	50Ω
Gain	2dBi
Connector	SMA male
Operation Temp.	-30° ~ +60°
Dimension (L*W*H)	61*Ø8 mm / 57* Ø8mm



Connector	Part no.
SMA male, straight	60064
SMA male, right angle	60024.RA

**Pattern E-Plane**

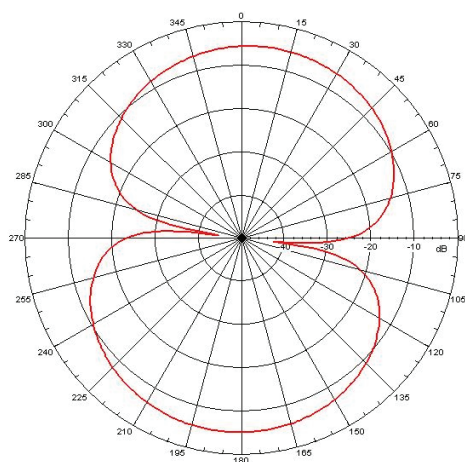

**Pattern H-Plane**

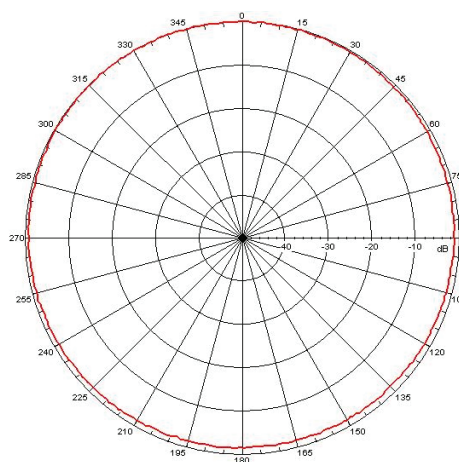

**Return Loss**

<b>WiMo Antennen und Elektronik GmbH</b>	
Am Gäxwald 14, D-76863 Herxheim Tel. (07276) 96680 FAX 9668-11	
http://www.wimo.com	e-mail: info@wimo.com

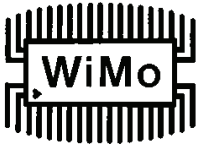

# Aufsteckantenne GSM 900/1800/1900/2100

Best.Nr. 60024 / 60024.RA

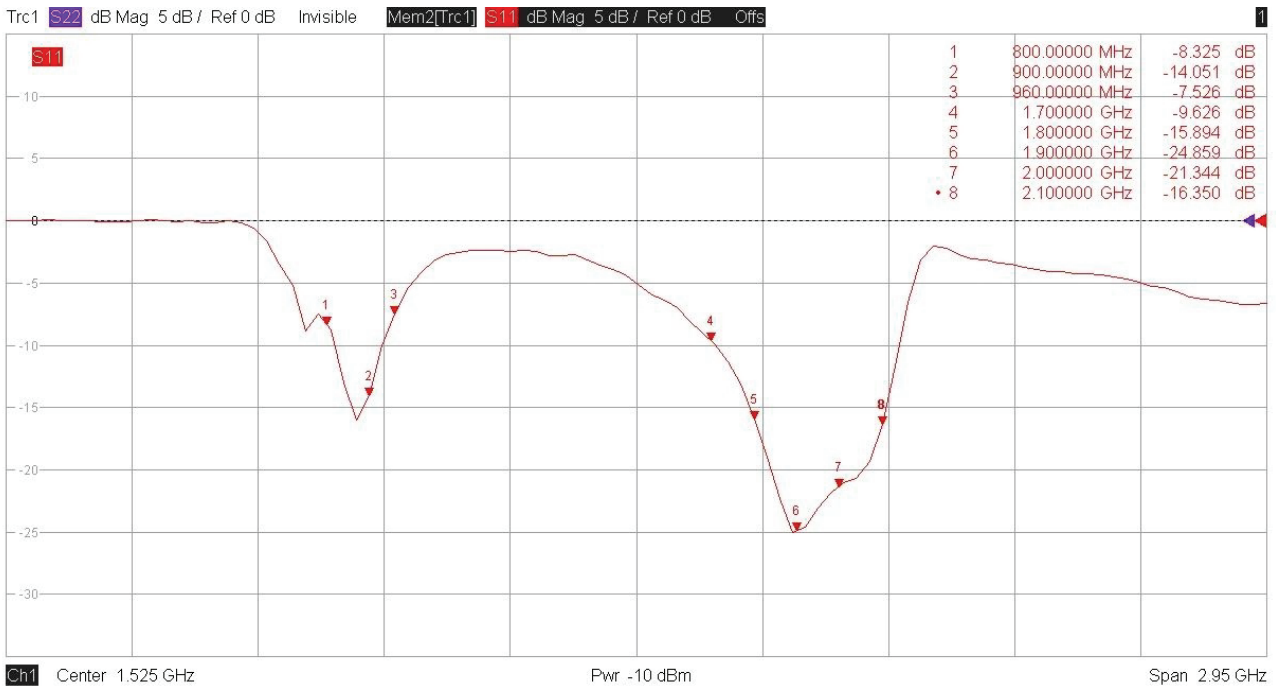
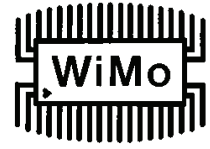

## SWR

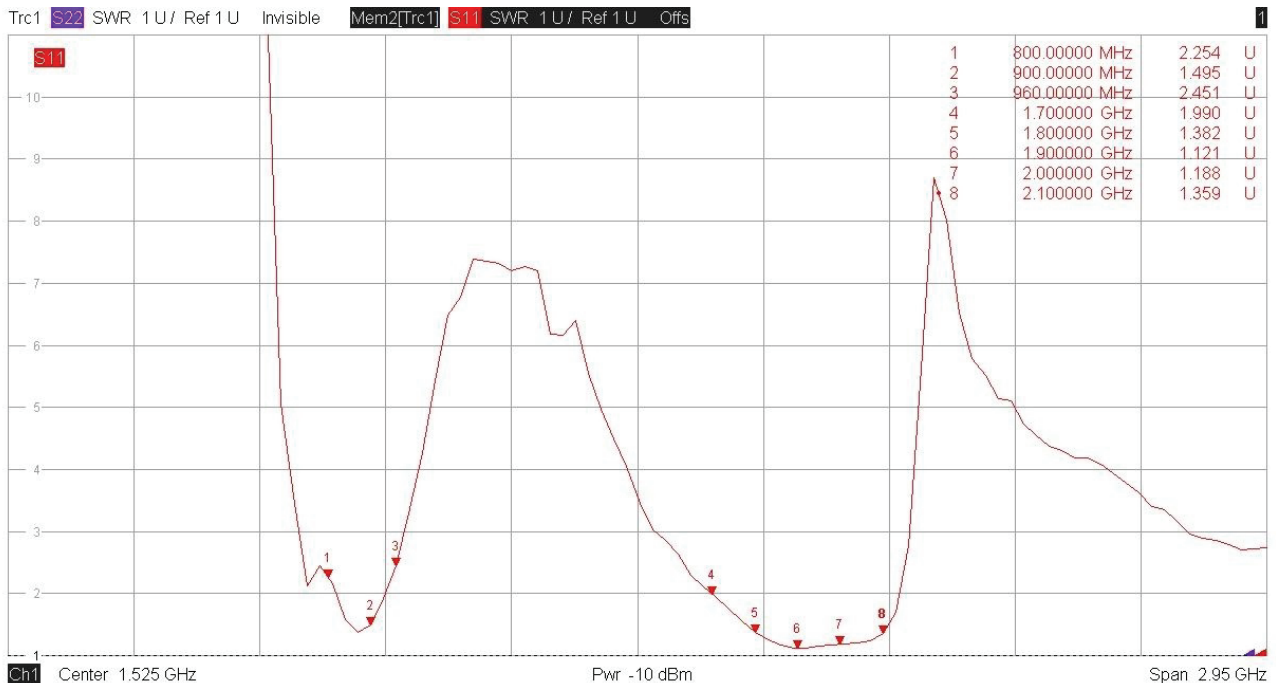

# WiMo Antennen und Elektronik GmbH

Am Gäxwald 14, D-76863 Herxheim Tel. (07276) 96680 FAX 9668-11

<http://www.wimo.com>

e-mail: [info@wimo.com](mailto:info@wimo.com)

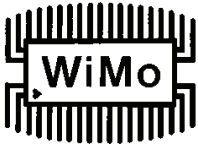

**Aufsteckantenne GSM 900/1800/1900/2100**

Best.Nr. 60024 / 60024.RA

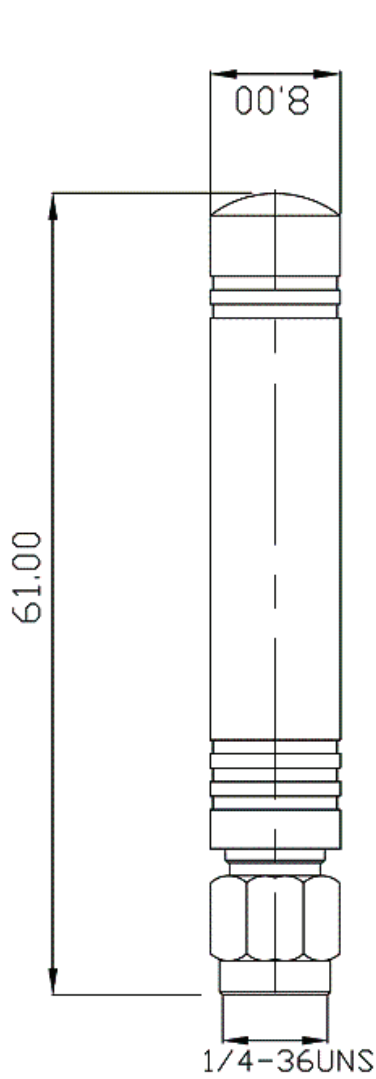
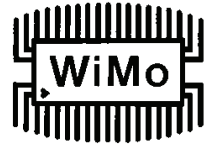

SMA MALE

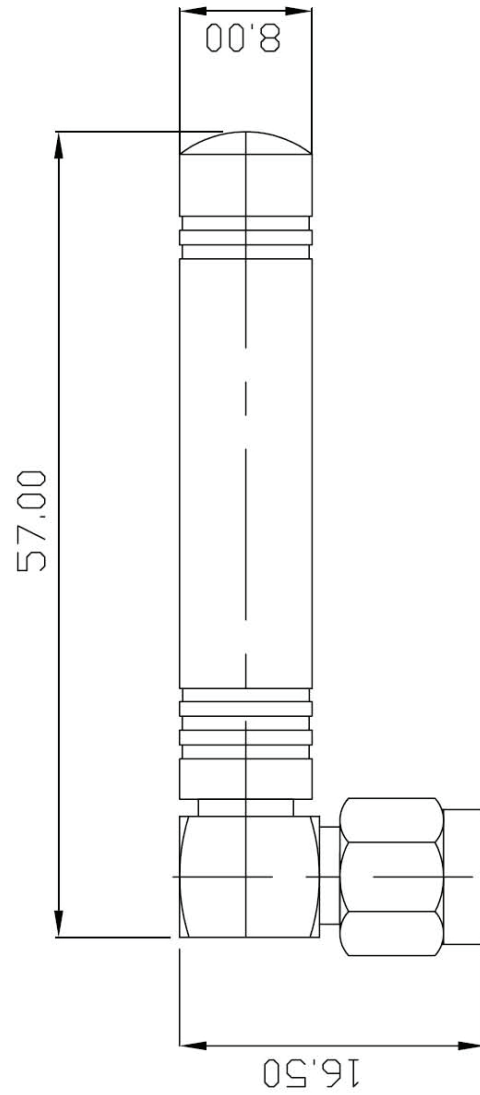

SMA MALE RIGHT ANGLE

**WiMo Antennen und Elektronik GmbH**

Am Gäxwald 14, D-76863 Herxheim Tel. (07276) 96680 FAX 9668-11

<http://www.wimo.com>

e-mail: [info@wimo.com](mailto:info@wimo.com)