

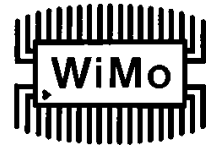

Einbauantenne 2.4 GHz IP54
Spritzwassergeschützt IP54, Best.Nr. 17014.IPEX



mit 6mm-Gewindestutzen und 13cm langem Anschlußkabel mit IPEX (U.FL®)-Stecker. Die Abdichtung des Gewindestutzens im Gehäuse ist vom Kunden sicherzustellen.
Lieferung mit Mutter und Zahnscheibe.

Splash proof 2.4GHz Antennas, IP54
With 6mm thread bolt and 13cm log cable with IPX (U.FL®) connector. The seal between antenna and housing must be provided by the customer. Length 114mm, gain 1dBi. Comes complete with nut and lock washer.

Specifications:

Frequency Range :	2.4 ~ 2.4835GHz
VSWR :	≤ 2.0
Impedance :	50Ω ± 5Ω
Gain :	1dBi
Polarization :	Vertical
Power Handling :	1 Watt
Beam Width :	H: 360° / E: 57°
Connector :	IPEX (others available on request)
Operation Temp. :	-30° ~ +60°
Material :	Radome: ABS Base: ABS
Dimension (L*W*H) :	Ø13*150 mm
Weight :	6g ± 2g
Color :	BLACK

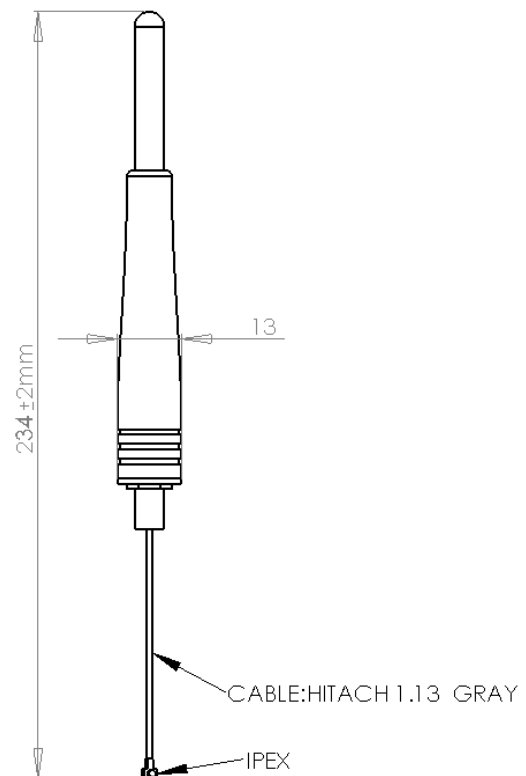

WiMo Antennen und Elektronik GmbH

Am Gäxwald 14, D-76863 Herxheim Tel. (07276) 96680 FAX 9668-11
<http://www.wimo.com> e-mail: info@wimo.com



Einbauantenne 2.4 GHz IP54
Spritzwassergeschützt IP54, Best.Nr. 17014.IPEX

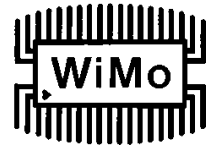

Return Loss

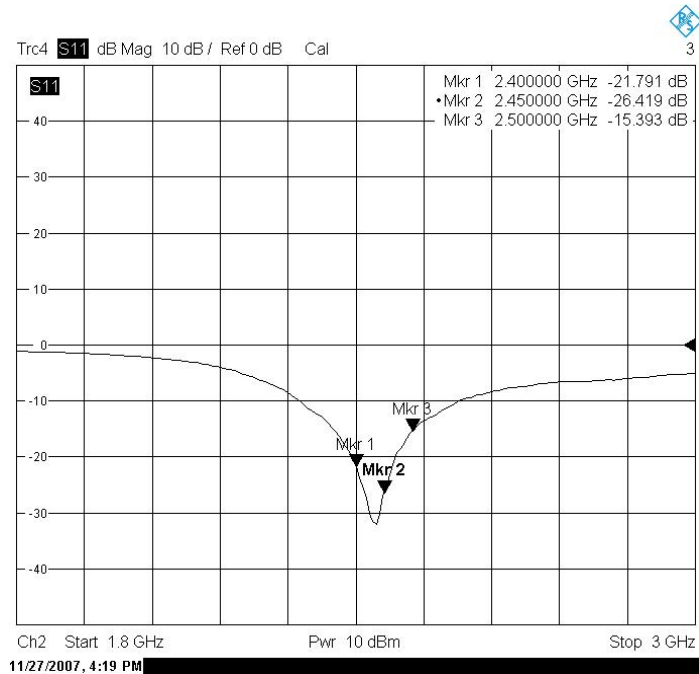

SWR

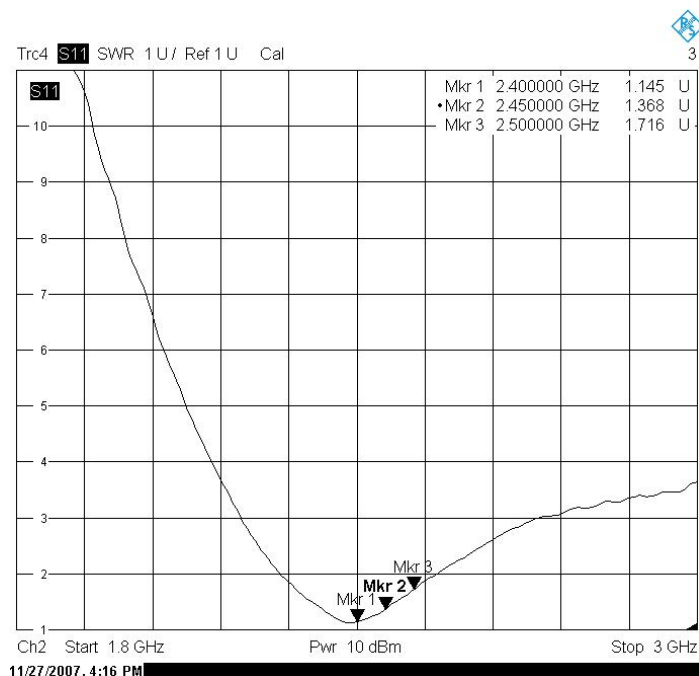

WiMo Antennen und Elektronik GmbH

Am Gäxwald 14, D-76863 Herxheim Tel. (07276) 96680 FAX 9668-11

<http://www.wimo.com>

e-mail: info@wimo.com

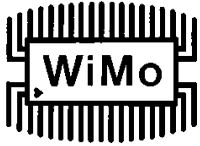

Einbauantenne 2.4 GHz IP54
Spritzwassergeschützt IP54, Best.Nr. 17014.IPEX



H Plane

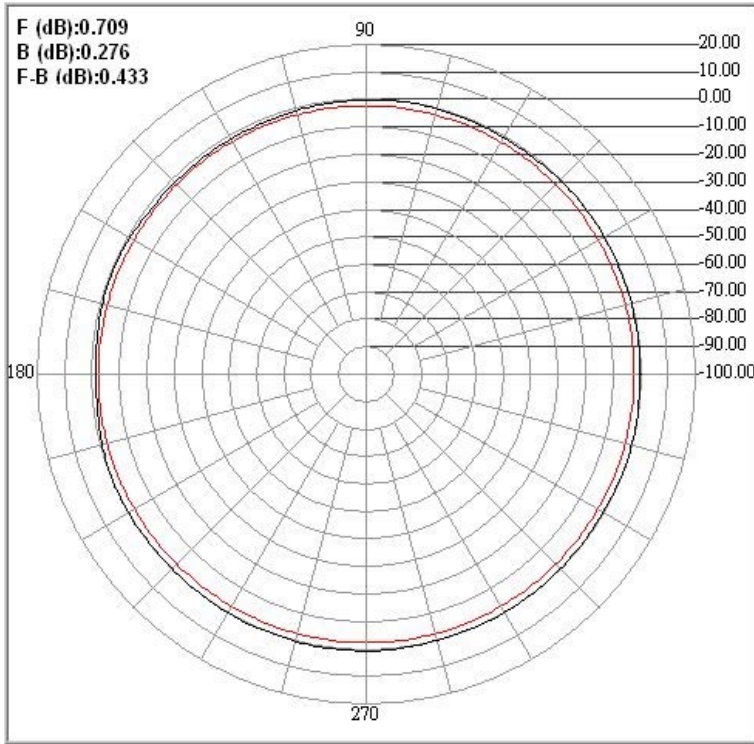

E Plane

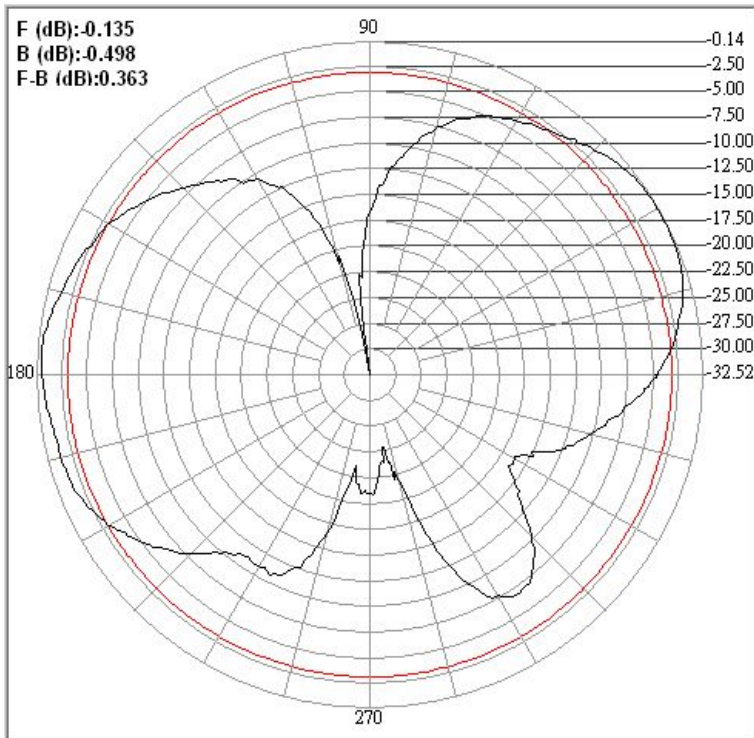

WiMo Antennen und Elektronik GmbH

Am Gäxwald 14, D-76863 Herxheim Tel. (07276) 96680 FAX 9668-11

<http://www.wimo.com>

e-mail: info@wimo.com