



# PA-5000-23

panel antenna 5.1-5.825 GHz, 23 dBi #18710.23



Sehr flache und formschöne 5 GHz Flachantenne mit 23 dBi Gewinn für Mast- oder Wandmontage.

Durch den geringen Öffnungswinkel sind die Antennen gut für Punkt-zu-Punkt Verbindungen (Richtfunk) geeignet. Großer Frequenzbereich 5100 - 5825 MHz, Anschluß N-Buchse, max. 10 Watt. Mit Mastschelle und Neig/Kipphalter für 30-50mm Mastdurchmesser.

Haube aus ABS, Halterung aus Zink-Druckguß, alle Schrauben/U-Bügel Edelstahl.

Very broadband flat panel antennas for 5.1 – 5.825 GHz, thus covering the whole band. Most suitable for point-to-point communications. Suitable for wall- or mast mount, comes with universal tiltable mounting bracket. Can be mounted for vertical or horizontal polarisation. Radome is ABS, mast bracket is zinc alloy, all mounting hardware is stainless.

technische Daten / technical data:

antenna type :	panel antenna
frequency range:	5.1-5.825 GHz
V.S.W.R:	<2.0
impedance :	50 ± 5 Ohm
gain:	23dBi
max. power:	10 W
polarization:	linear
Beamwidth H:	16°
beamwidth V	16°
weight:	1360 g
connector:	N female
color:	white
dimensions:	322.6x322.6x12 mm
operation temp.	-30 - +60°
order no.:	18710.23

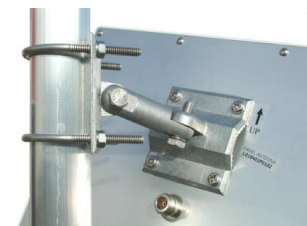
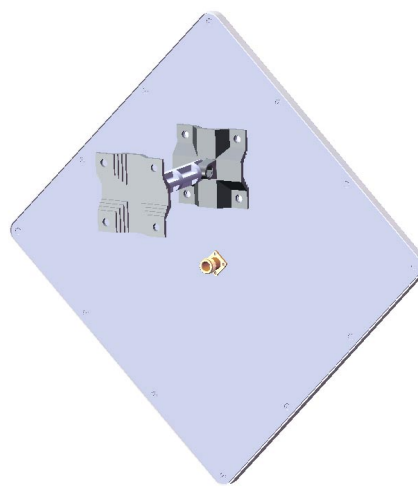
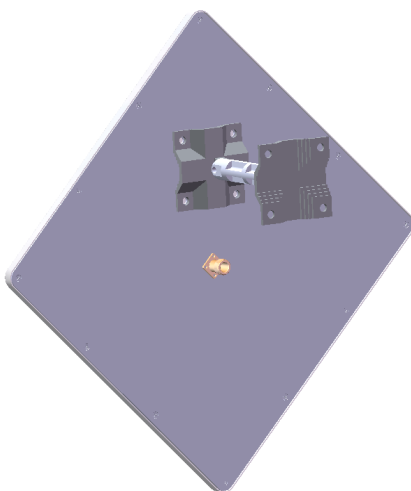

## WiMo Antennen und Elektronik GmbH

Am Gäxwald 14, D-76863 Herxheim Tel. (07276) 96680 FAX 9668-11

<http://www.wimo.com>

e-mail: [info@wimo.com](mailto:info@wimo.com)

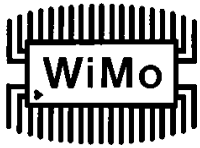

# PA-5000-23

panel antenna 5.1-5.825 GHz, 23 dBi #18710.23

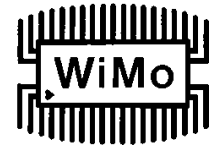

## Return Loss

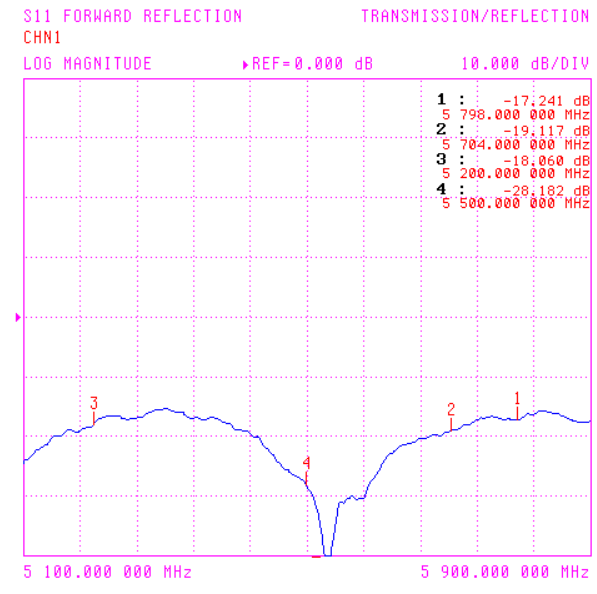

## pattern H-plane

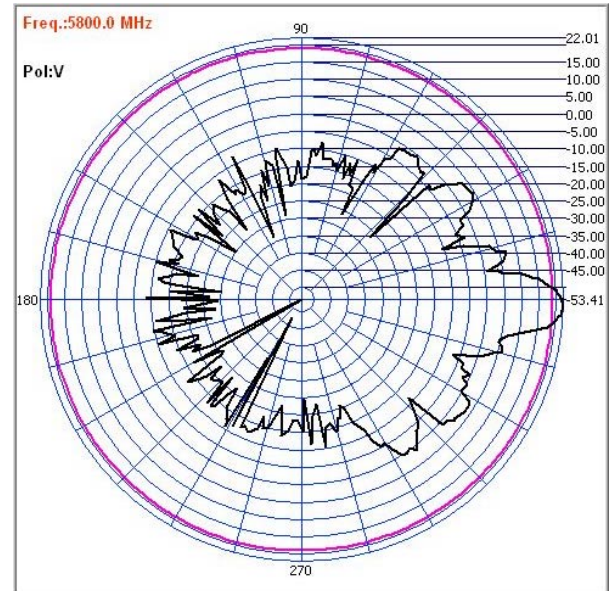

## SWR

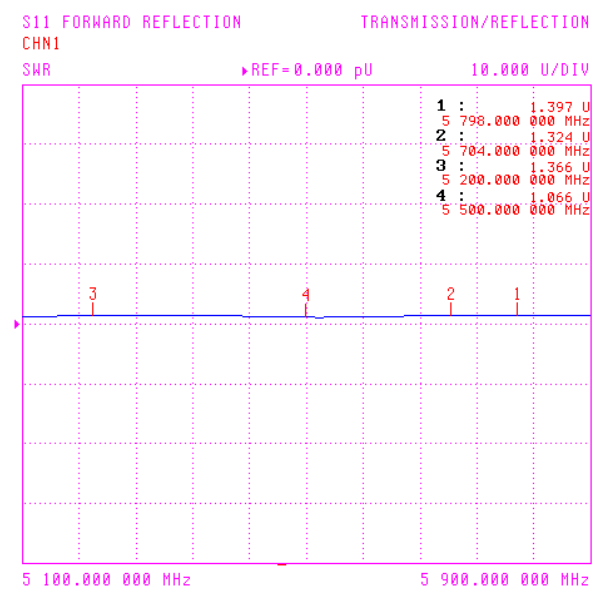

## pattern E-plane

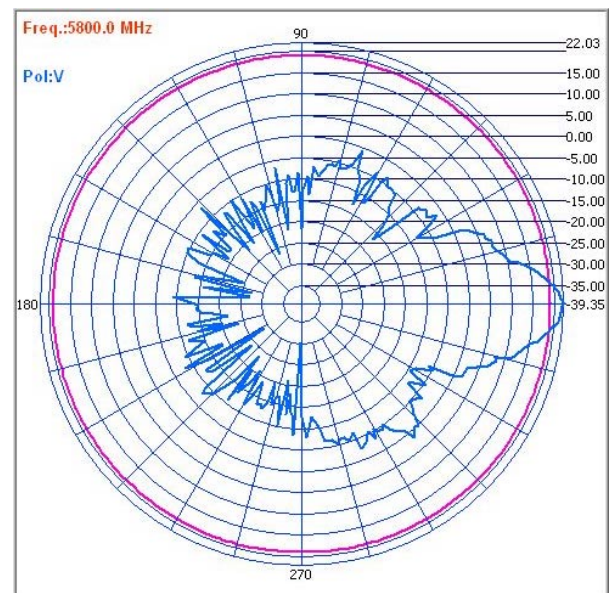

# WiMo Antennen und Elektronik GmbH

Am Gäxwald 14, D-76863 Herxheim Tel. (07276) 96680 FAX 9668-11  
<http://www.wimo.com> e-mail: [info@wimo.com](mailto:info@wimo.com)

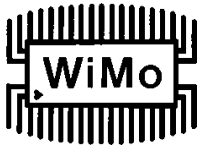

**PA-5000-23**  
panel antenna 5.1-5.825 GHz, 23 dBi #18710.23

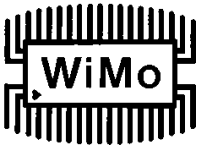

Dimensions

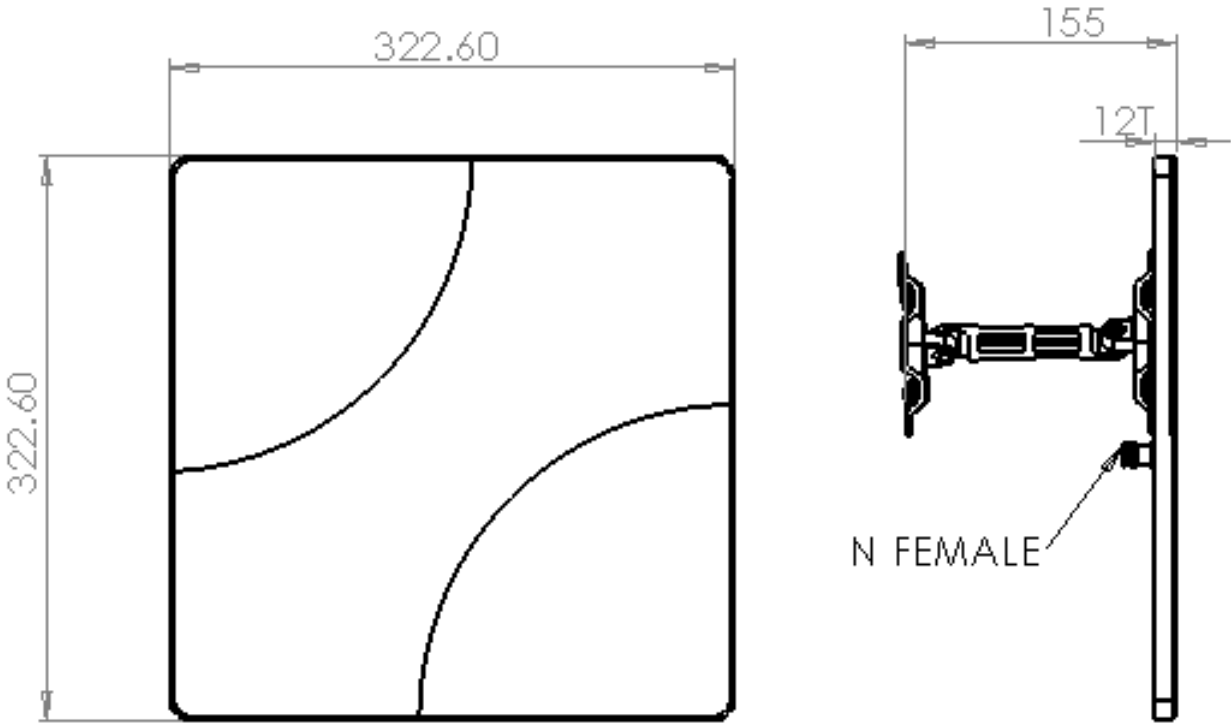

**WiMo Antennen und Elektronik GmbH**  
Am Gäxwald 14, D-76863 Herxheim Tel. (07276) 96680 FAX 9668-11  
<http://www.wimo.com> e-mail: [info@wimo.com](mailto:info@wimo.com)