

Ultra Beam

Dynamic Antenna Systems

MANUAL "STANDARD"

YAGI 2-3-4-6 ELEMENTS 6-20m



Rev. 1.10

INTRODUCTION

UltraBeam produced its first antenna in 2008.

Since then there was a progressive and continuous improvement in design and manufacturing of antennas, below the main innovations are listed:

- **2008** dual-driver circuitry to optimize spacing (necessary on some models)
- **2009** VRS System to improve reliability compared to spring-belt retraction systems
- **2010** Engine mounts with direct connection to the elements for a complete mechanical seal
- **2016** RCU-06 digital controller with color touch display

Some innovations have become an international reference, appreciated and used today successfully even from other brands.

The assembly (processing only performed by the client) is certainly one of the most important aspects of an antenna. Therefore, particular attention has been paid to the technical and mounting procedures in order to make the assembly simple, intuitive and fast, even for people not much experienced in manual labor techniques.

Last but not least, the realization of electrical Plug and Play wiring, as made by UltraBeam, makes it extremely simple to connect the electric components properly. Otherwise this part would be sometimes difficult to understand and/or often source of post installation problems.

The main steps of assembling an UltraBeam antenna are in fact common to many models.

Simply by reading this quick guide you will acquire and memorize the necessary procedures in a few minutes. This makes the assembly of your antenna simple and clear, and, above all, free of any doubts.

The only real difference between the different models is the length of the boom and the number of motor units installed on it, but as mentioned above, the procedures and assemble techniques remains unchanged. There are only five steps to successfully install an UltraBeam antenna and once the major procedures are acquired, it will be easy to apply them to your model.

Step	Description
1	Boom assembly
2	Mounting brackets and motor unit on the boom
3	Preparation of telescope elements
4	Elements Installation on motor unit
5	Electric Wiring

In contrary to what you might think, this guide will show the simplicity with which you can achieve both the mechanical and electrical assembly of an UltraBeam

1) BOOM ASSEMBLY

UltraBeam uses a square boom of section 60 x 60 x 3 mm for most models of antennas. Only the heavier models are equipped with sections of 80 x 80 x 3 mm or 4 mm.

The boom may have 1 to 4 junctions depending on the model. Only the „2 elements Yagis“ does not have junctions. In the following photo sequence, the single junctions are shown from figure 1 to 5.



Fig.1



Fig.2



Fig.3

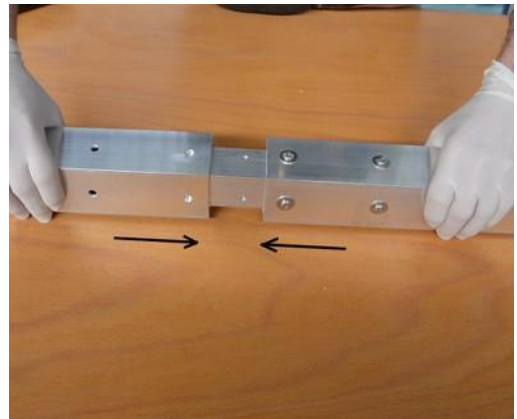

Fig.4



Fig.5

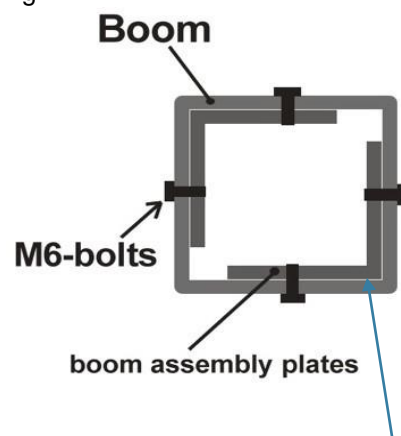

Fig.6

NOTE: Before tightening the screws, make sure that both sides of the L are in contact with the boom.

NOTE: After the orientation of the boom is fixed, we recommend attaching a drainage hole at the bottom of the end caps so that any water that may penetrate the boom connectors over time can also drain off again.

2) MOUNTING BRACKETS / MOTOR UNIT

The mounting of the engine mounts consists of 3 simple steps

Place the aluminum support on the boom and fix it by means of the 4 M6 bolts and lower plates block (fig.1)

Before tightening the bolts, check with a set square that the motor support is at 90 ° with respect to the boom, this will ensure a perfect parallelism between the elements.

Note: In order to position the motor unit on the boom correctly you should have a look at the antenna diagram on page 8. Depending on your model, you need to know that the two external motor units of the antenna (any model) will always have to be placed at the boom ends, with the cable facing towards the center of the boom (as shown in the pictures), so no measurements needs to be verified.

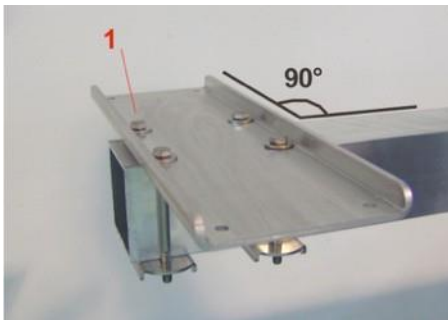

Fig.1

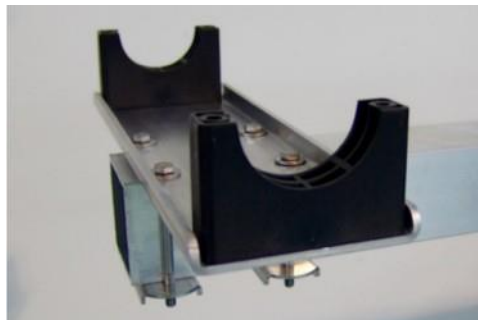

Fig.2

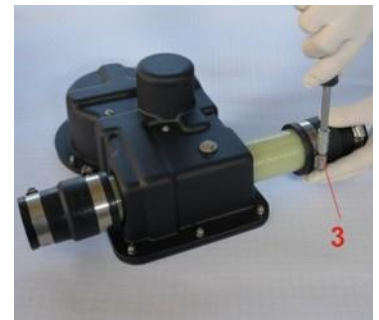

Fig.3

Place the lower ABS collars in correspondence of the outer holes of the support (fig.2)

Insert the rubber sleeves on the motor unit and tighten the internal clamp (fig. 3)

Place the motor unit onto the support (Figure 4) and place the upper ABS collars (fig.5)

Insert the M6 x 110mm bolts and tighten them.

Figure A shows the correct position of the motor unit with respect to the boom.



Fig.A

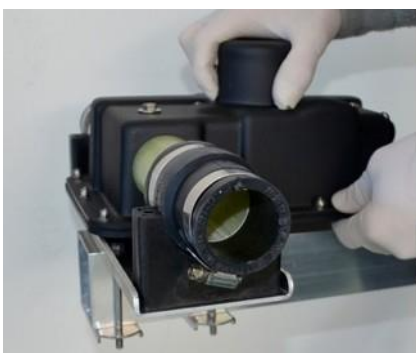

Fig.4



Fig.5



Fig.6

Note: To tighten the screws, apply to the list below

BOLTS TIGHTENING

Passo	Description	Tightening Nm
M6	Screw bracket motor unit (1)	10
Endless screw	Screw rubber cap clamp (3)	6
M6	Bolt collars ABS (2)	8
M6	Boom junction screw	8

3) PREPARATION OF TELESCOPIC ELEMENT

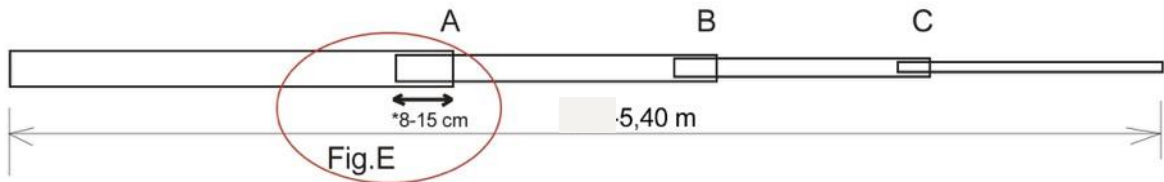

The glass fiber elements are formed by 4 telescopic sections. Its possible to extend every single conical junction to reach a total length of about 5.4m maximum extension. The length can change depending on the model.

The maximum length of each individual section can be different from the others in order of installation. Normally, the internal section must remain inside the element that hosts it for a length between 8-15 cm (fig.E). For this reason the maximum length depends on the set-up and may differ in some cm, but this is not a fault and does not matter.

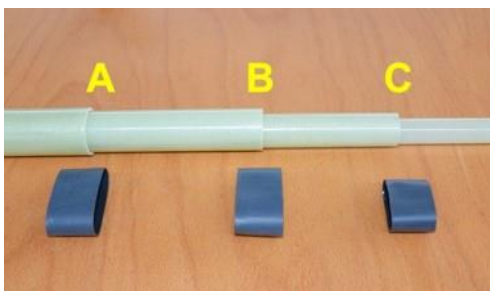

Fig.1

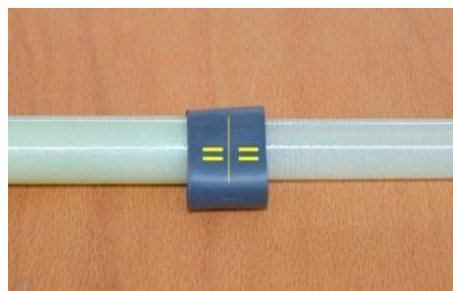

Fig.2



Fig.3

The three joints of the element are sealed by means of thermo-tightening with internal adhesive of appropriate diameter (Figure 1)

Place the sleeve exactly in the center of the junction (Figure 2)

Heat the sleeve with a heat gun until the same has not adhered completely to the element, the leakage of the adhesive to form a ring all around the edge will indicate that it has reached the correct temperature.

NOTE: excessive heat can damage the element

4) INSTALLATION OF ELEMENTS ON MOTOR UNIT

Loosen the outside of the rubber sleeve so that the element can slide up to where it can move, it will enter 10 cm. (Fig.1)

Tighten the rubber sleeve clamp (Figure 2) *

Repeat on opposite side.



Fig.1



Fig.2

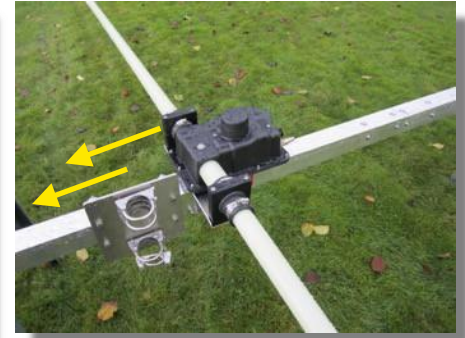

Fig.3

MAST/BOOM plate

All models are supplied with aluminium or s/s mast / boom plate. Mast collars, boom brackets and bolts are made of stainless steel.

Each antenna model will have the appropriate number and diameter of collars to match the weight of the model.

On all antenna models with three motor units, the plates will always be fixed to the center boom. However, in cases where you need to increase the distance between the central element and the mast, simply move the plate away from the motor (Fig.3) to achieve the necessary space for your set-up. This will be necessary only when you install the antenna on a large corros-section wheeled tower.

On antenna models with 4 or more elements the position of the plate will be indicated directly on the boom.

In both cases you are free to move from the specified location and, if necessary, you can balance the antenna (only for repositioning more than 10 cm) by placing a small inner weight at the lighter boom end.



Diameter of mast clamps supplied with antennas

U-Bolt Diameter mast mm.	50	60	65
2 elements 6-20 / 6-40 / UB20MX	✓	/	/
3 elements 6-20 / UB50 / 4 el. DX	✓	optional	/
UB640-VL1.3 / VL2.3	✓	optional	/
4 elements 6-20	✓	optional	optional
3 elements 6-40 / 4 elements 6-40	optional	✓	optional
UB640-VL3.4 / UB40MX	optional	✓	optional

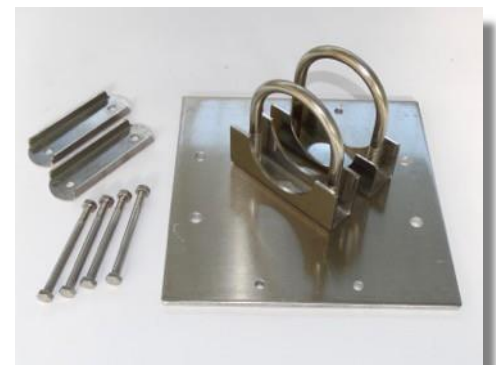

BOOM Guying

Most UltraBeam models don't need any tie rope, the square section boom on models with a boom length within 6 meters offer a very high stiffness and remain perfectly straight. Only models with boom lengths over 9 meters include a guying kit for the boom.

Models that have boom guying:

- 4 ELEMENTS 6-20
- 4 ELEMENTS 6-20 DX
- 6 ELEMENTS 6-20 DX
- 4 ELEMENTS 6-40



Fig.1

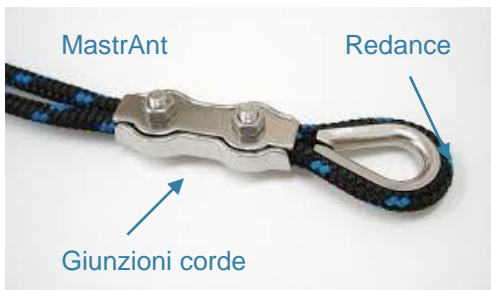

Fig.2

The models shown are provided with a complete kit of excellent MastrAnt ropes with suitable diameter for the model.

All strings and joints thimbles are made of stainless steel.

On the two outer sections of the boom holes are drilled on which you simply insert and tighten the through bolt with eyelet head (fig.1) which will be inserted in the appropriately closed rope with double stainless junction (fig.2)

The ropes are supplied with proper length and allow you to make your personal set-up "A"

The vertical measurement "A" between boom and mast to which the strings will be attached to, should be between 1.5 -2.5 m. The heavier the antenna, the greater will be the distance from the antenna boom. For example on a 4 or 6-40 elements it should not be lower than 2 m.

In any case and regardless of the model you should never fix the ropes at distances "A" less than one meter. This would bring an excessive load on the ropes and poor alignment of the boom.

With the ropes kit you get a junction for mast collars to tie the ropes, of course you can use your own fixture if already present on your mast.

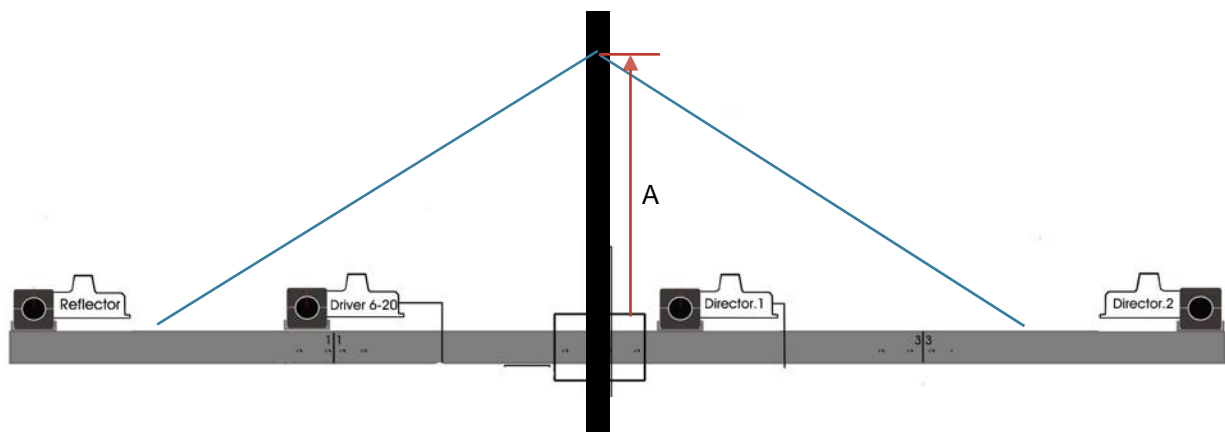

5) ELECTRICAL WIRING

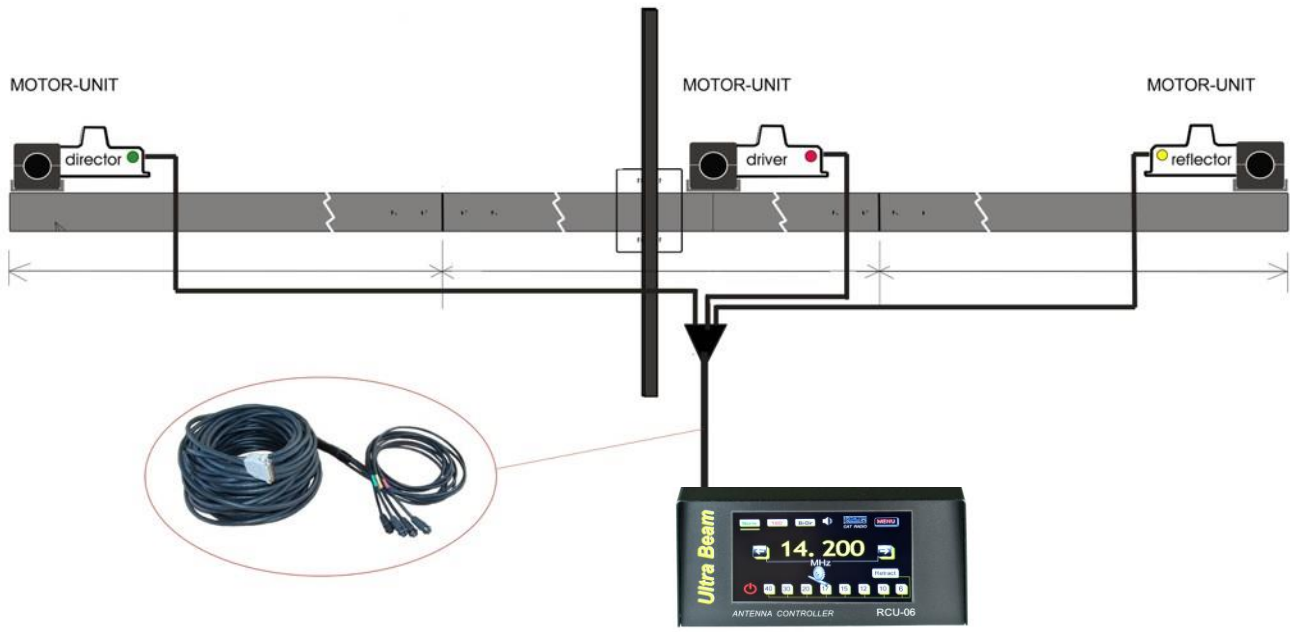

The electrical wiring, built and assembled by UltraBeam, is the best solution for electric connection between the antenna and the electronic controller.

In these cases, the antenna motor units will be equipped with multi-pole female connectors.

Simply plug in the connectors to the motor unit and the DB25 to the controller. This avoids any chance of operating errors and guarantees high reliability over time.

Furthermore, the assembled wiring does not contain any junction points along the route, which is often a cause of bad electrical contacts especially for external systems. Each wire runs from the controller to the motor. For more details, see 'wiring' manual on download page of www.ultrabeam.de



The multi-wire cables used in the construction of the wiring are build specifically according to UltraBeam specifications.

Water resistance and protection against UV rays make the wiring particularly suitable for outdoor use and offer increased reliability compared to common commercial cables.

The connectors used are IP68 compliant with gold contacts by Switchcraft Inc.

ANTENNA MODEL SCHEME

SCHEMA -Yagi 2 elements 6-20

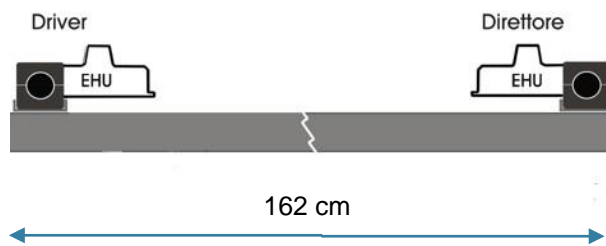

Boom 1 x 162 cm
Square 60 x 60

SCHEMA - Yagi 3 elements 6-20

POSIZIONAMENTO MOTOR UNIT SU BOOM

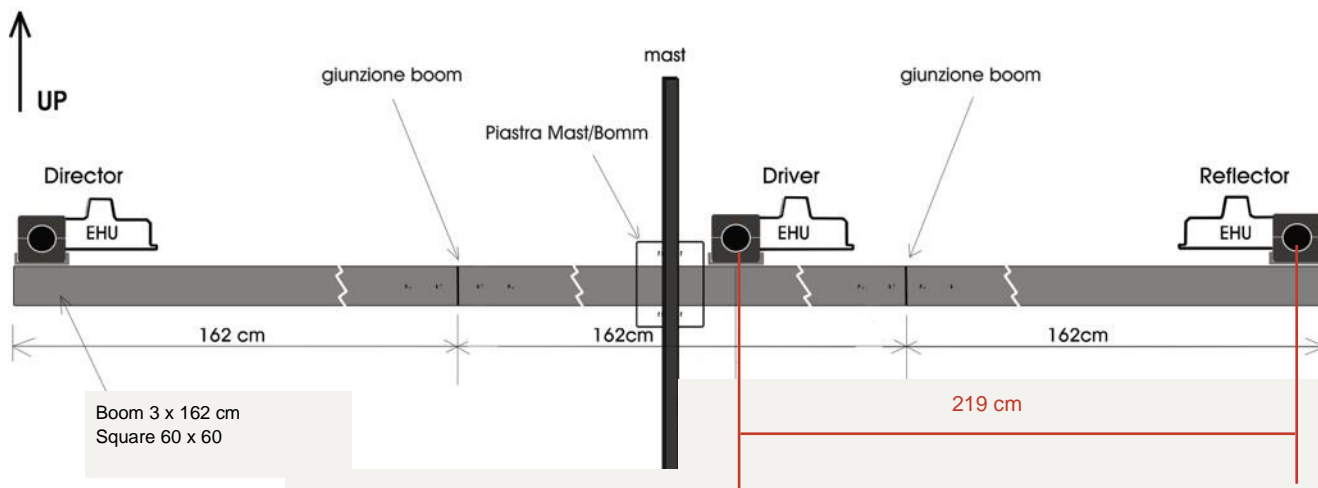

4 ELEMENTS YAGI 6-20

-POSIZIONAMENTO MOTOR UNIT SU BOOM
-POSITIONING MOTOR UNIT ON BOOM

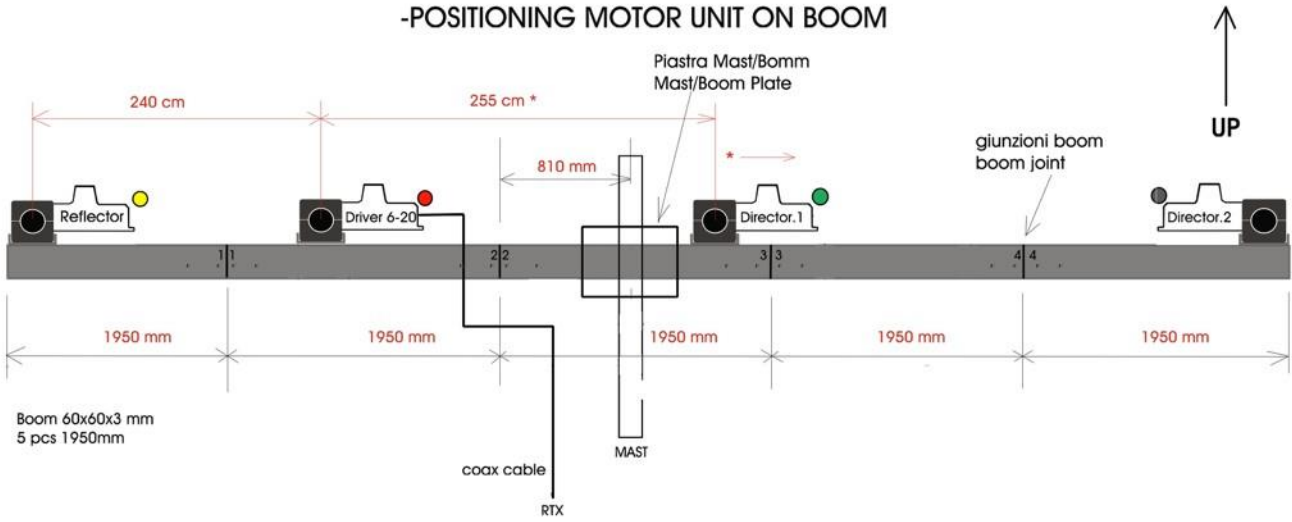

4 ELEMENTS 6-20 DX

-POSIZIONAMENTO MOTOR UNIT SU BOOM
-POSITIONING MOTOR UNIT ON BOOM

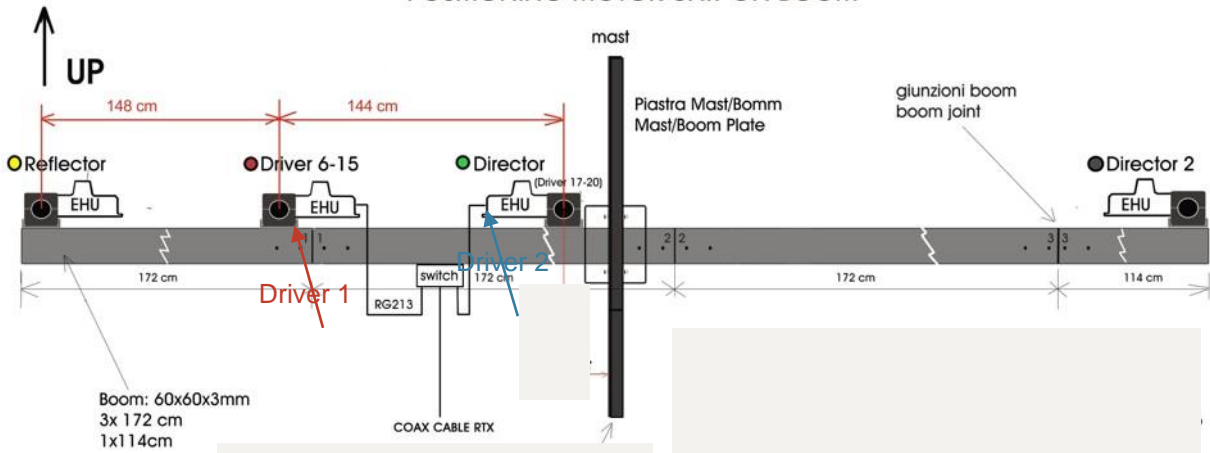

YAGI 6 ELEMENTS 6-20 DX

-POSIZIONAMENTO MOTOR UNIT SU BOOM
-POSITIONING MOTOR UNIT ON BOOM

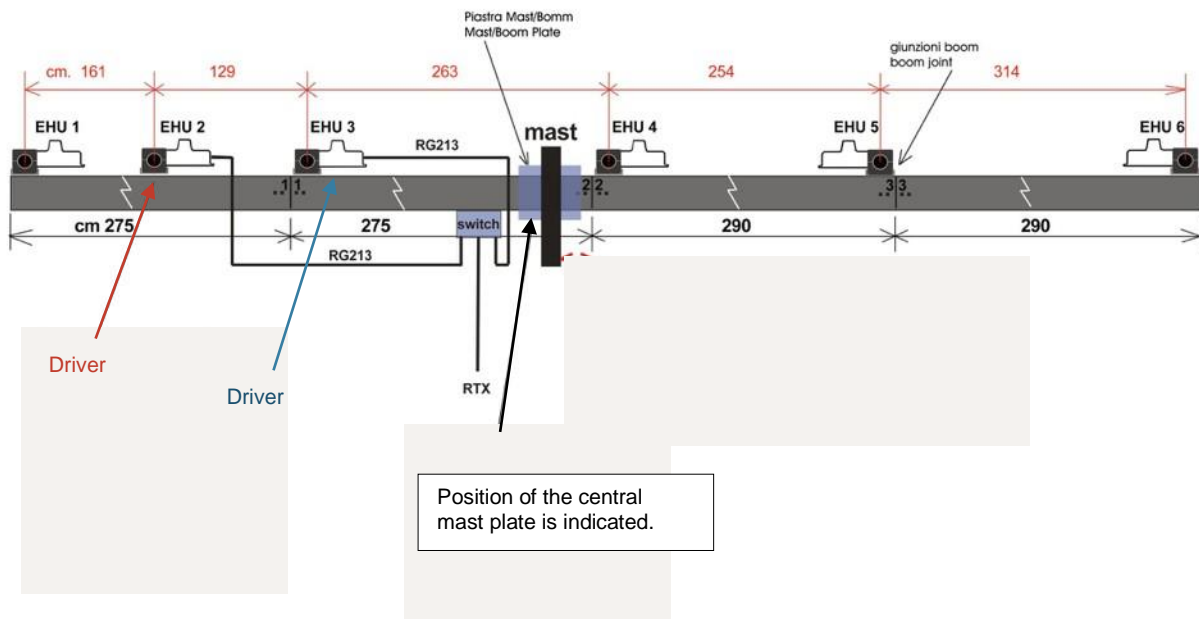

CONCLUSIONS

A manual of a few pages may seem deceptively simplistic ... actually the use of only 8 pages to describe the assembly of 2-3-4 elements yagi 6-20 are proof of quality design and how extremely simple as well as intuitive the assembly of a UltraBeam antenna really is.

Texts, images and graphics have been prepared to offer the user maximum ease of self learning and memorizing.

In contrast to a manual consisting of many pages, which can only confuse an OM having never installed an antenna of this type, could provide too much information and too many new procedures to him.

Reading new manuals while waiting to receive your new antenna will allow you to perform a quick installation, safe and free of errors.

Therefore, a careful reading is recommended in order to acquire the assembly methods which, as you may have seen, are really very intuitive.

Do work when your mind already knows what to do and provides a better end result in fewer time than a set-up in which you should consult the manual step by step for each individual operation.

Finally, and not least ...

Perform the antenna set-up exclusively as described in the manuals.

Avoid any variable and / or customization.

If you plan to do something that is not described in the manual, it means you should better not do it.

WiMo Antennen und Elektronik GmbH

Am Gäxwald 14, D-76863 Herxheim Tel. (07276) 96680 FAX 9668-11

<http://www.wimo.com>

e-mail: info@wimo.com