

18621.SMA ADHESIVE ANTENNA

Electrical Specifications:

Frequency Range	824~960/1710~2170/ 2300~2700MHz
VSWR	≤ 3
Gain	0.5/1/2dBi
Impedance	50Ω±5Ω
Polarization	Vertical
Beamwidth	NA
H-PLANE	820~960MHz:75° 1710~2170MHz:47° 2300~2700MHz:55°
E-PLANE	360°
Max. Power	1 Watt
Isolation	NA

Mechanical Specifications:

Connector	SMA MALE
Cable	1.5m PRO-100 low-loss
Operation Temp.	-30°C ~ +60°C
Material-Radome	PVC
Dimension (L*W*H)	154.25*29.25*4.2 ±5mm
Weight	38g ± 4g
RoHS compliant	Yes

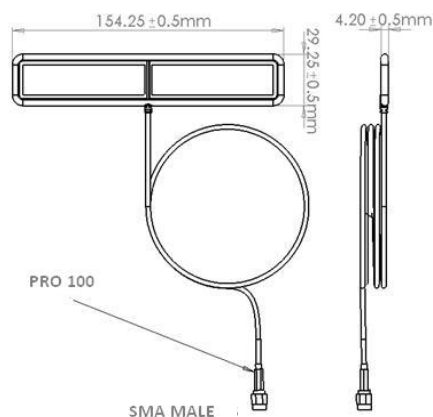

VSWR

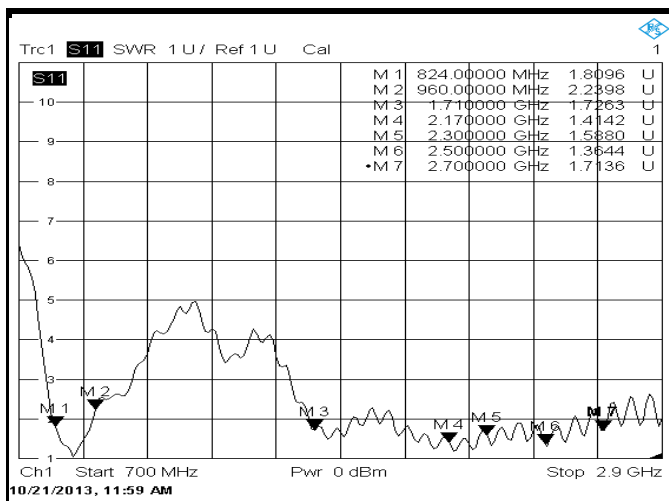

S11

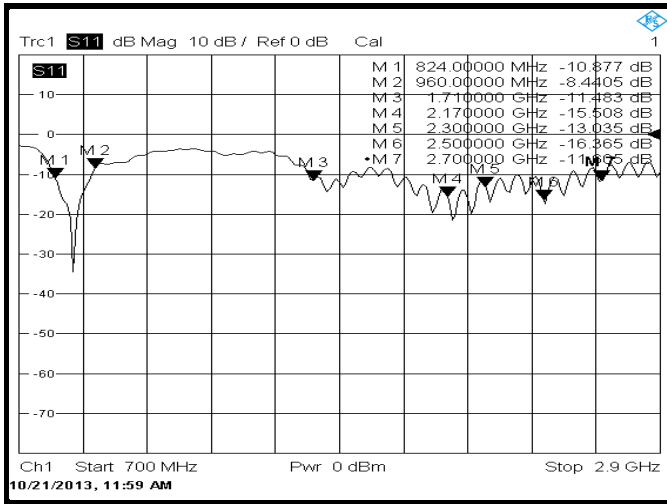

Radiation Pattern

H Plane 824-960MHz

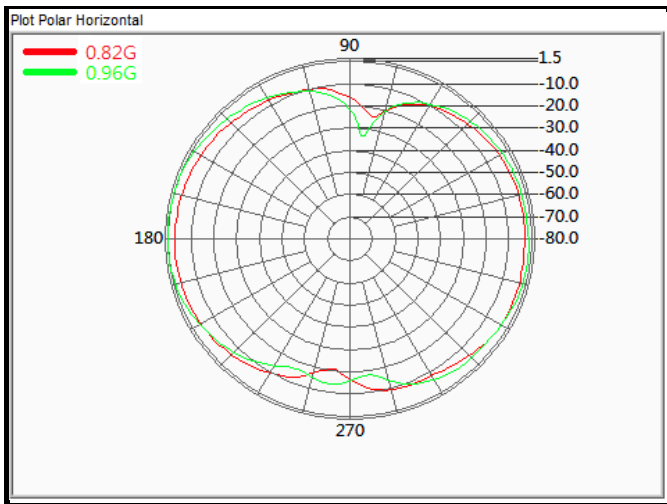

H Plane 1710-2170MHz

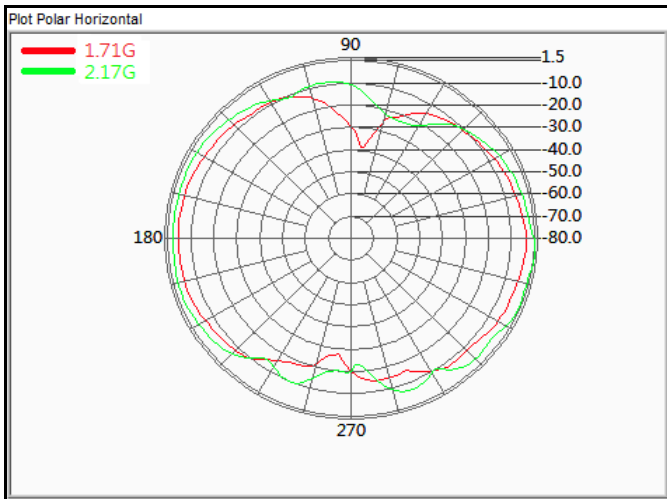

H Plane 2300~2700MHz

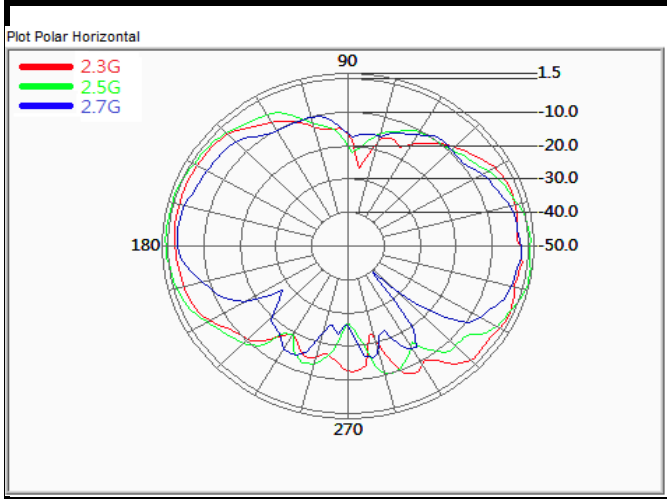

Radiation Pattern

E Plane 824-960MHz

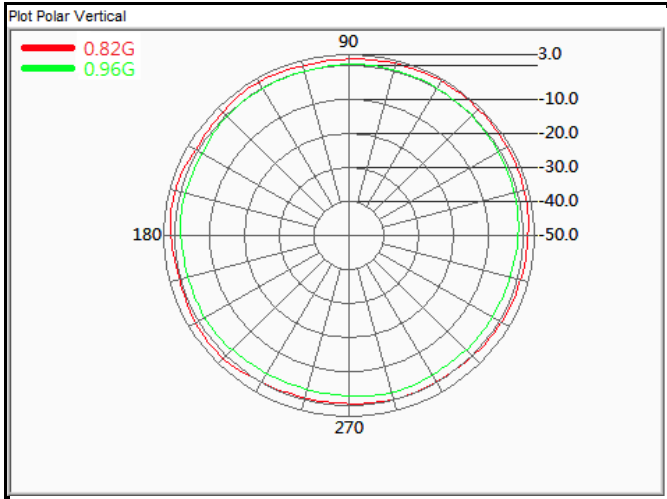

E Plane 1710-2170MHz

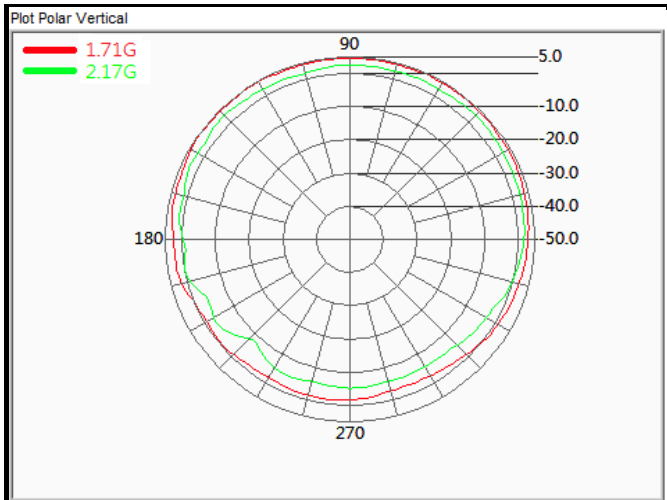

H Plane 2300~2700MHz

