

Aufsteckantenne 5 GHz

18720.3

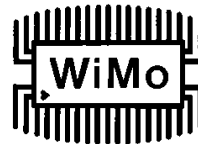

Aufsteckantenne mit SMA-Anschluß, auf Anfrage auch mit anderen Steckern lieferbar.

Equipment antennas with SMA connector, available with other connectors upon request.

antenna type :	rubber antenna
model no.:	18720.3
frequency range:	5.1-5.9 GHz
v.s.w.r:	< 2.0
impedance:	50 Ohm
gain:	5 dBi
max. power:	1 W
radiation:	omni
polarization:	vertical
weight:	20g ± 2g
connector type:	SMA male
color:	black
length:	115 mm



WiMo Antennen und Elektronik GmbH

Am Gäxwald 14, D-76863 Herxheim Tel. (07276) 96680 FAX 6978
<http://www.wimo.com> e-mail: info@wimo.com

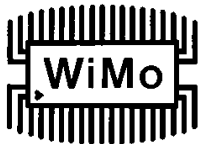

Aufsteckantenne 5 GHz

18720.3

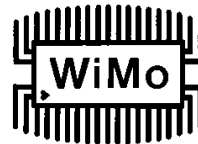

RETURN LOSS

S11 FORWARD REFLECTION TRANSMISSION/REFLECTION
CHN1

LOG MAGNITUDE ▶REF=0.000 dB 10.000 dB/DIV

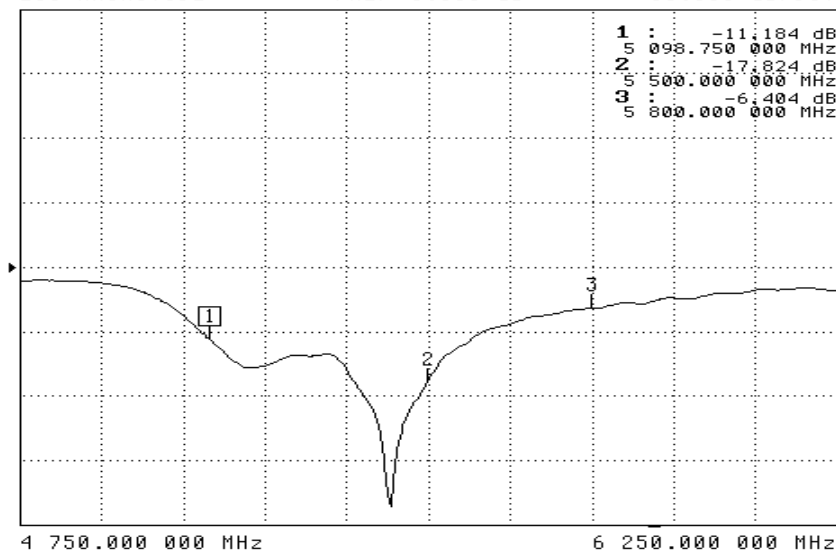

SWR

S11 FORWARD REFLECTION TRANSMISSION/REFLECTION
CHN1

SWR ▶REF=10.000 U 10.000 U/DIV

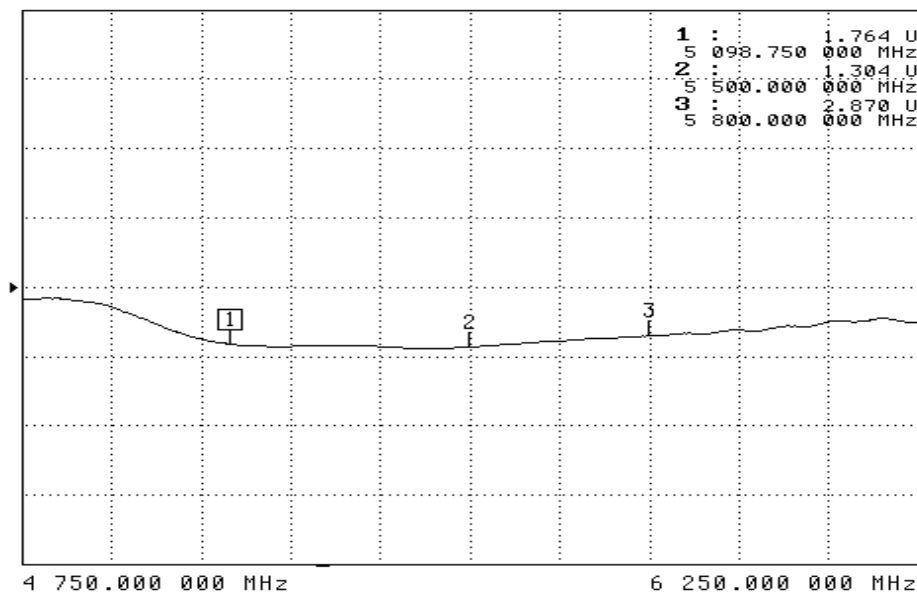

WiMo Antennen und Elektronik GmbH

Am Gäxwald 14, D-76863 Herxheim Tel. (07276) 96680 FAX 6978

<http://www.wimo.com>

e-mail: info@wimo.com

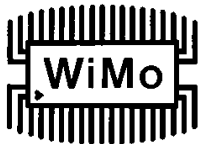

Aufsteckantenne 5 GHz

18720.3

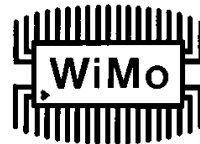

Plot Polar Vertical

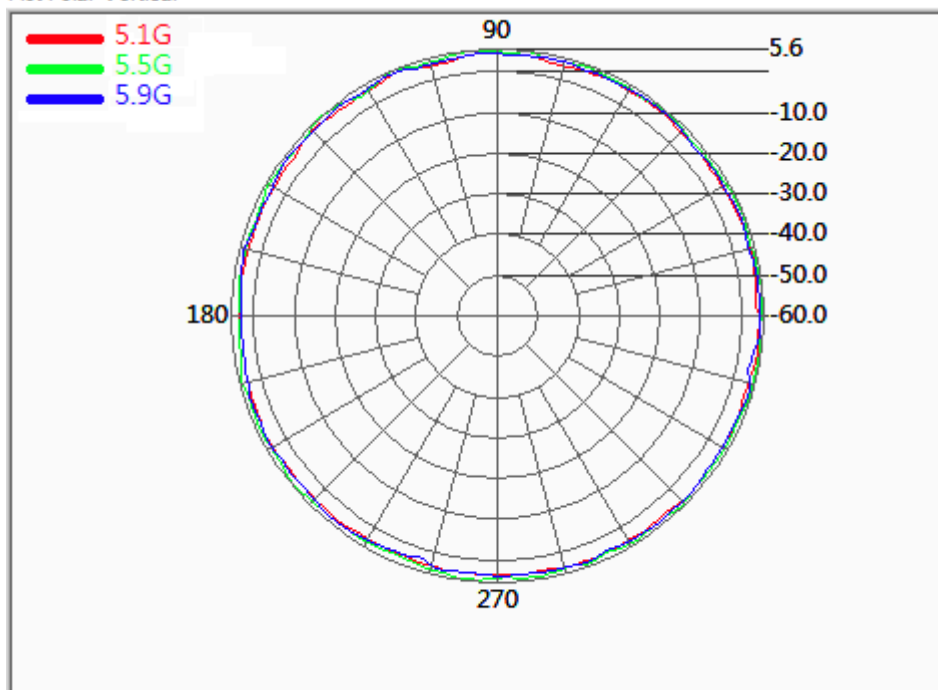

Plot Polar Horizontal

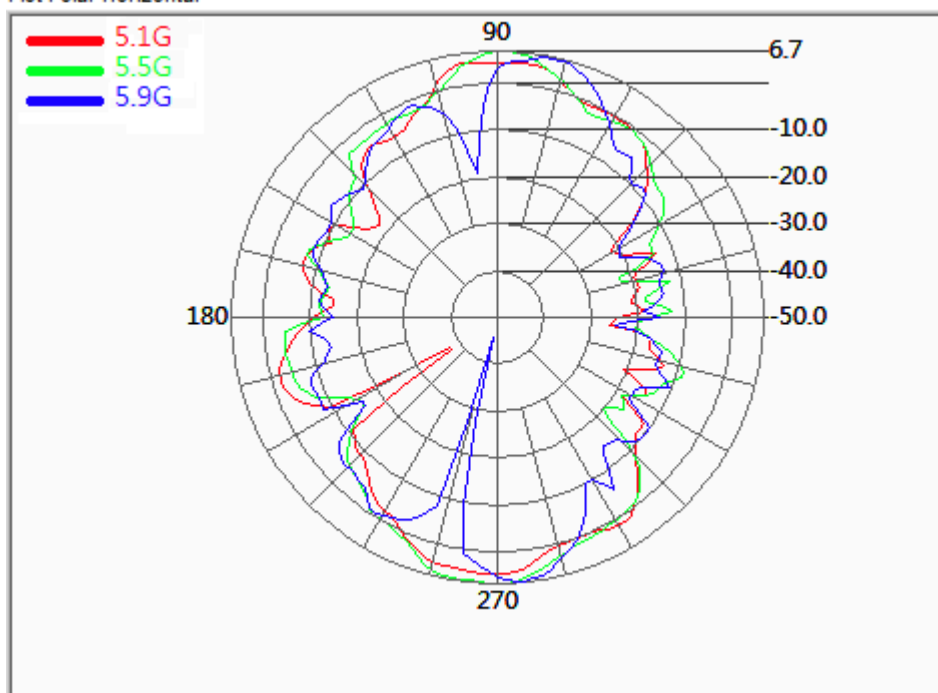

WiMo Antennen und Elektronik GmbH

Am Gäxwald 14, D-76863 Herxheim Tel. (07276) 96680 FAX 6978

<http://www.wimo.com>

e-mail: info@wimo.com