

5GHz Aufsteckantenne m. Knickgelenk

5100 MHz - 5800 MHz
Best.Nr. 18722.07

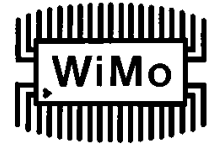

Aufsteckantenne mit Knickgelenk für 5.1 - 5.8 GHz. Anschluss SMA, somit passt diese Antenne direkt auf viele Endgeräte.

Equipment antenna with knuckle for 5.1 - 5.8 GHz. SMA connector, so this antenna fits directly to many devices.

Specifications:

Model No.	18722.07
Gain (dBi):	7dBi
Antenna Typ:	Dipole
Polarization:	Linear Vertical
V.S.W.R.:	≤ 1.8
Frequency:	5100-5800MHz
Connector:	SMA
Power:	50W
Impedance:	50 Ω
Dimensions:	299x13.7mm
Weight:	45g

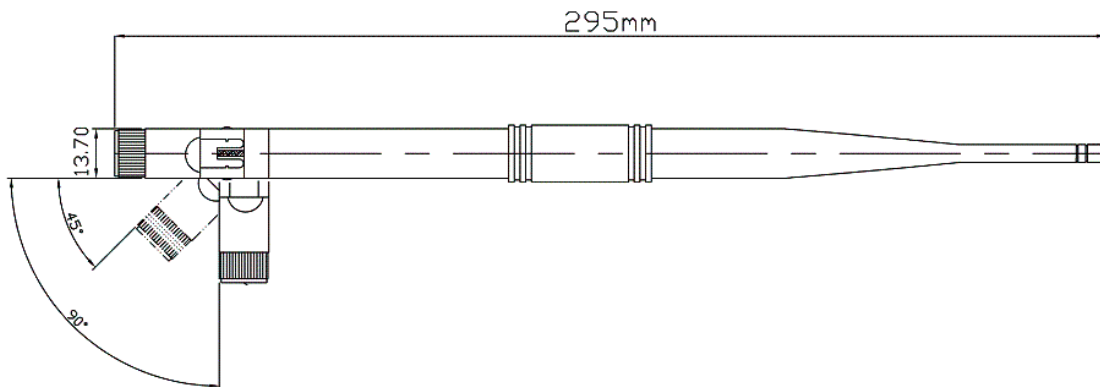

WiMo Antennen und Elektronik GmbH

Am Gäxwald 14, D-76863 Herxheim Tel. (07276) 9668-0 FAX 9668-11

<http://www.wimo.com>

e-mail: info@wimo.com



5GHz Aufsteckantenne m. Knickgelenk

5100 MHz - 5800 MHz
Best.Nr. 18722.07

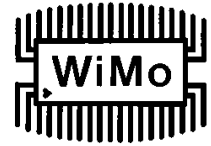

SWR

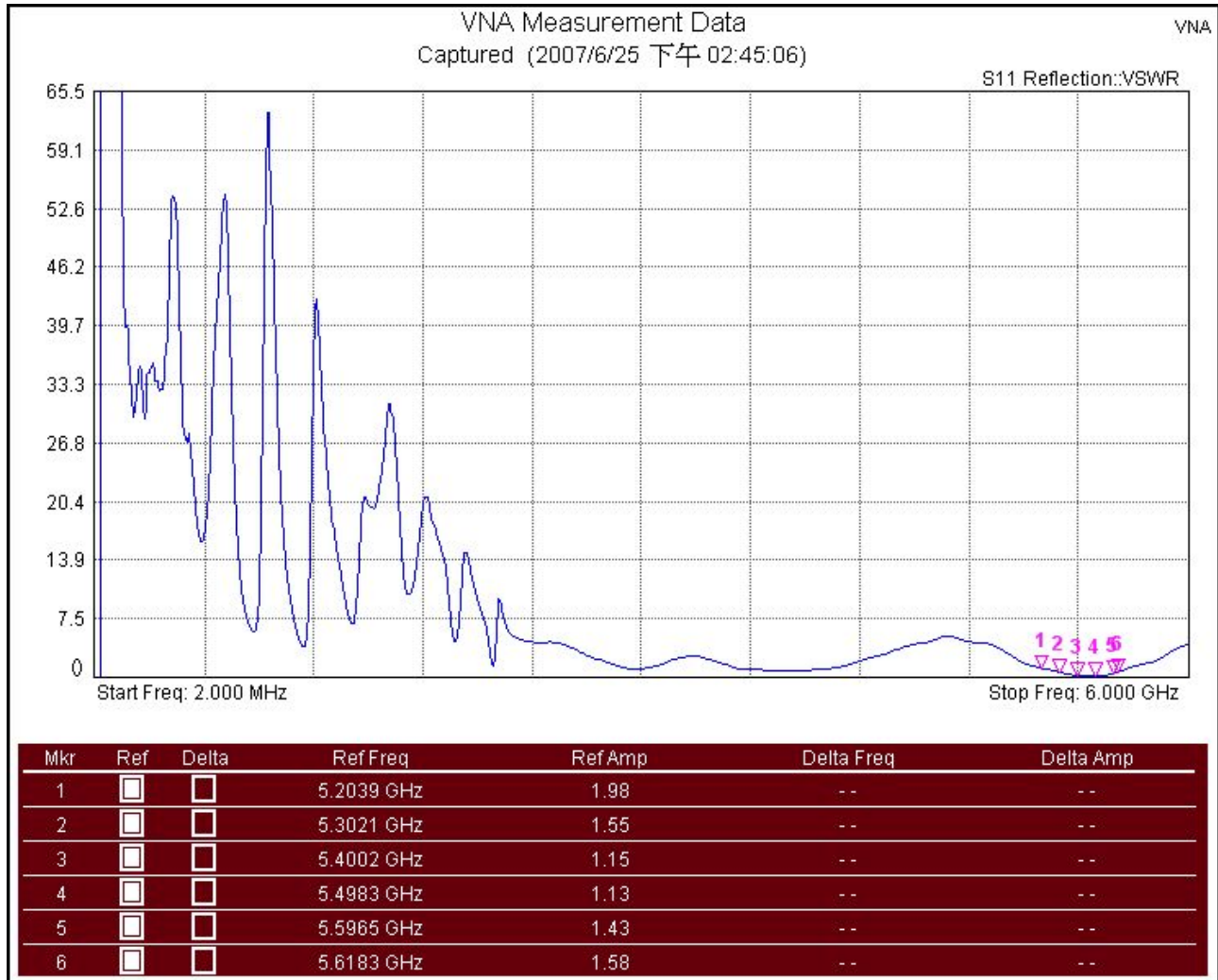

Measurement Parameters

Calibration Status	On	Serial Number	651009
Data Points	551	Base Ver.	V1.48
Output Power	High	App Ver.	V1.48
Start Frequency	2.000 MHz	Date	2007/6/25 下午 02:45:06
Stop Frequency	6.000 GHz	Device Name	

WiMo Antennen und Elektronik GmbH

Am Gäxwald 14, D-76863 Herxheim Tel. (07276) 9668-0 FAX 9668-11

<http://www.wimo.com>

e-mail: info@wimo.com

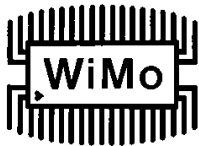

5GHz Aufsteckantenne m. Knickgelenk

5100 MHz - 5800 MHz

Best.Nr. 18722.07

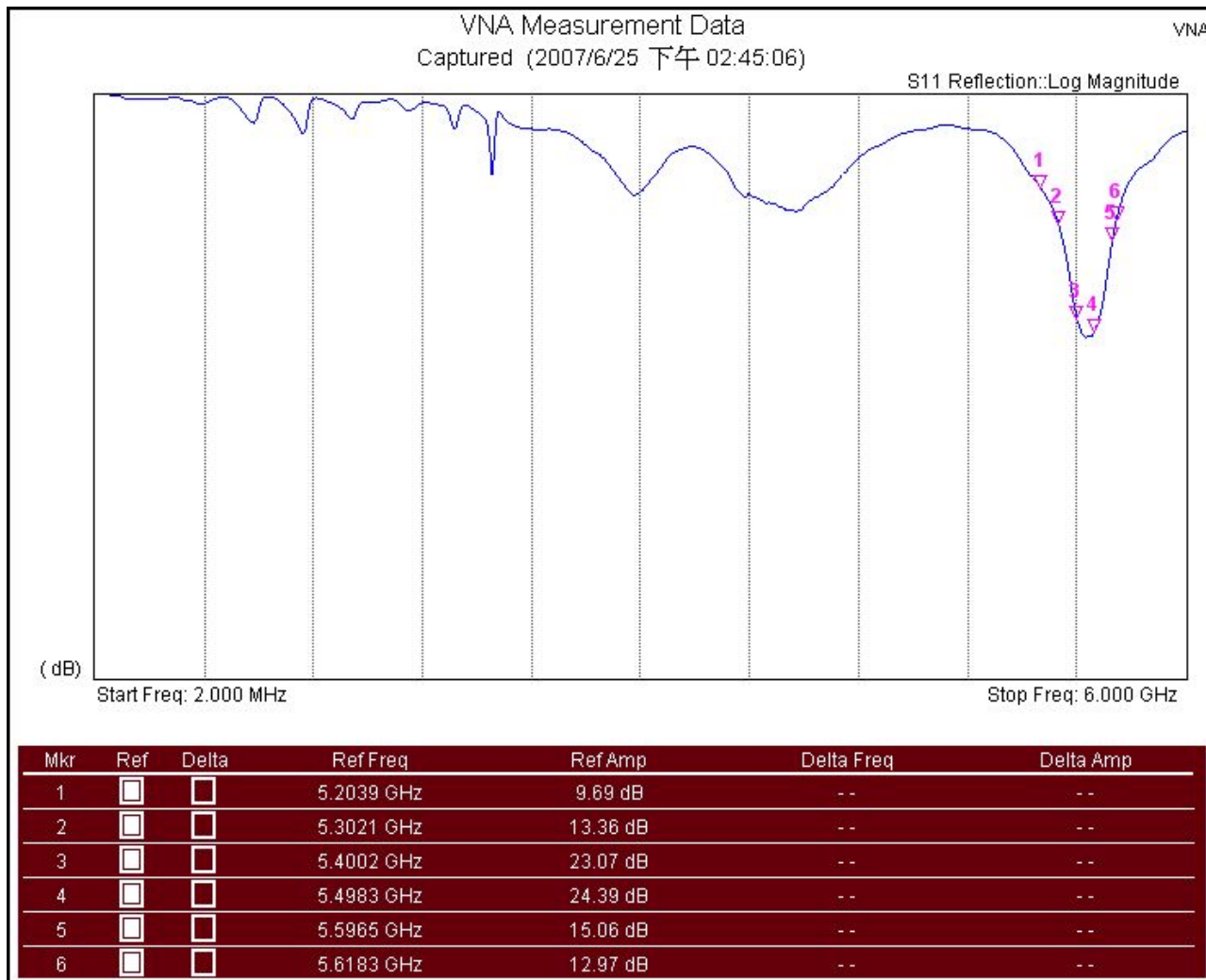
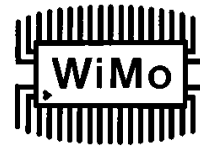

Measurement Parameters

Calibration Status	On	Serial Number	651009
Data Points	551	Base Ver.	V1.48
Output Power	High	App Ver.	V1.48
Start Frequency	2.000 MHz	Date	2007/6/25 下午 02:45:06
Stop Frequency	6.000 GHz	Device Name	

WiMo Antennen und Elektronik GmbH

Am Gäxwald 14, D-76863 Herxheim Tel. (07276) 9668-0 FAX 9668-11

<http://www.wimo.com>

e-mail: info@wimo.com



5GHz Aufsteckantenne m. Knickgelenk

5100 MHz - 5800 MHz

Best.Nr. 18722.07

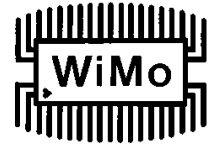

H-Plane

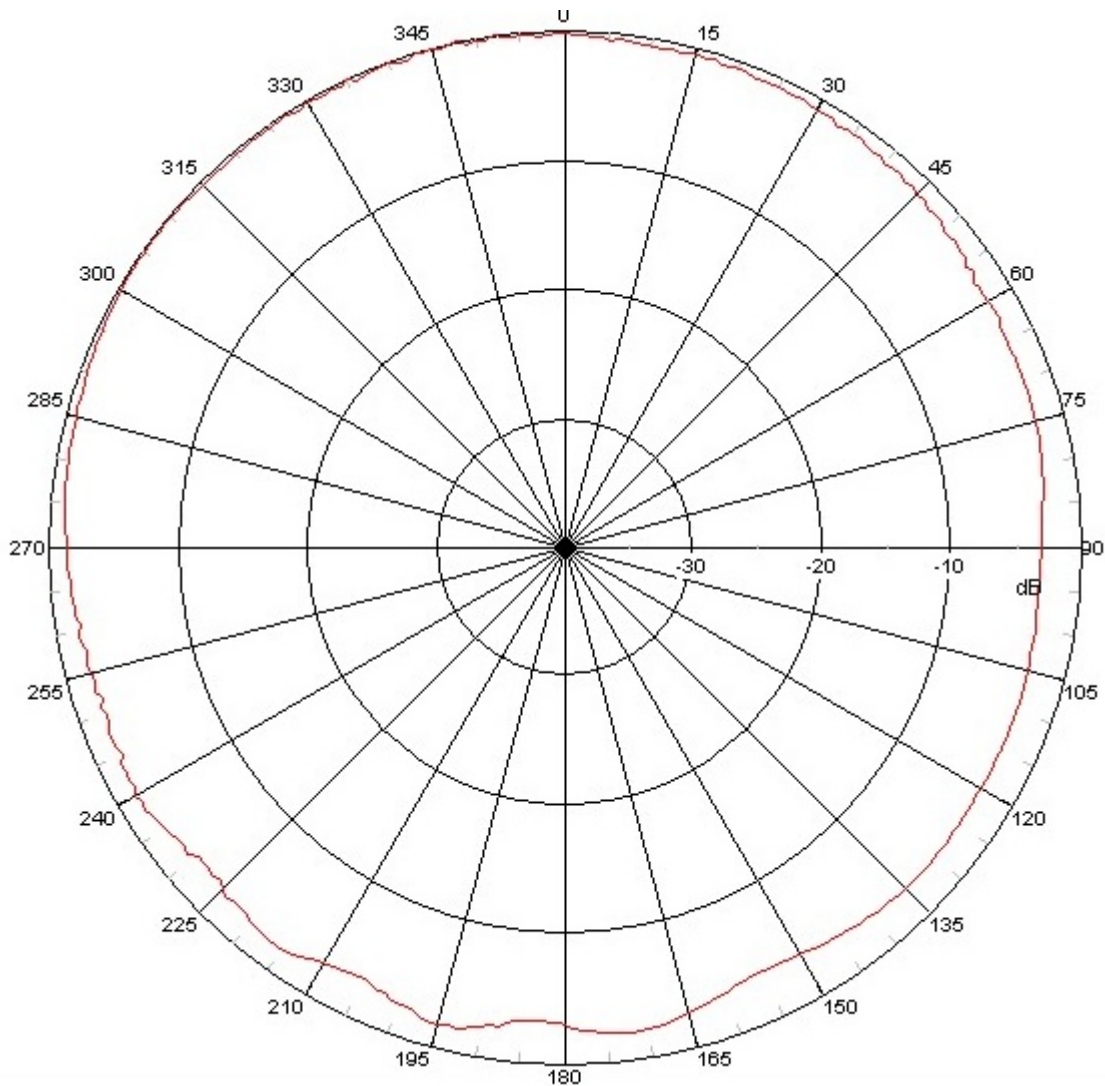

WiMo Antennen und Elektronik GmbH

Am Gäxwald 14, D-76863 Herxheim Tel. (07276) 9668-0 FAX 9668-11

<http://www.wimo.com>

e-mail: info@wimo.com



5GHz Aufsteckantenne m. Knickgelenk

5100 MHz - 5800 MHz

Best.Nr. 18722.07

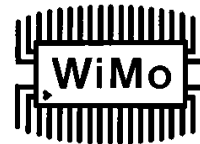

E-Plane

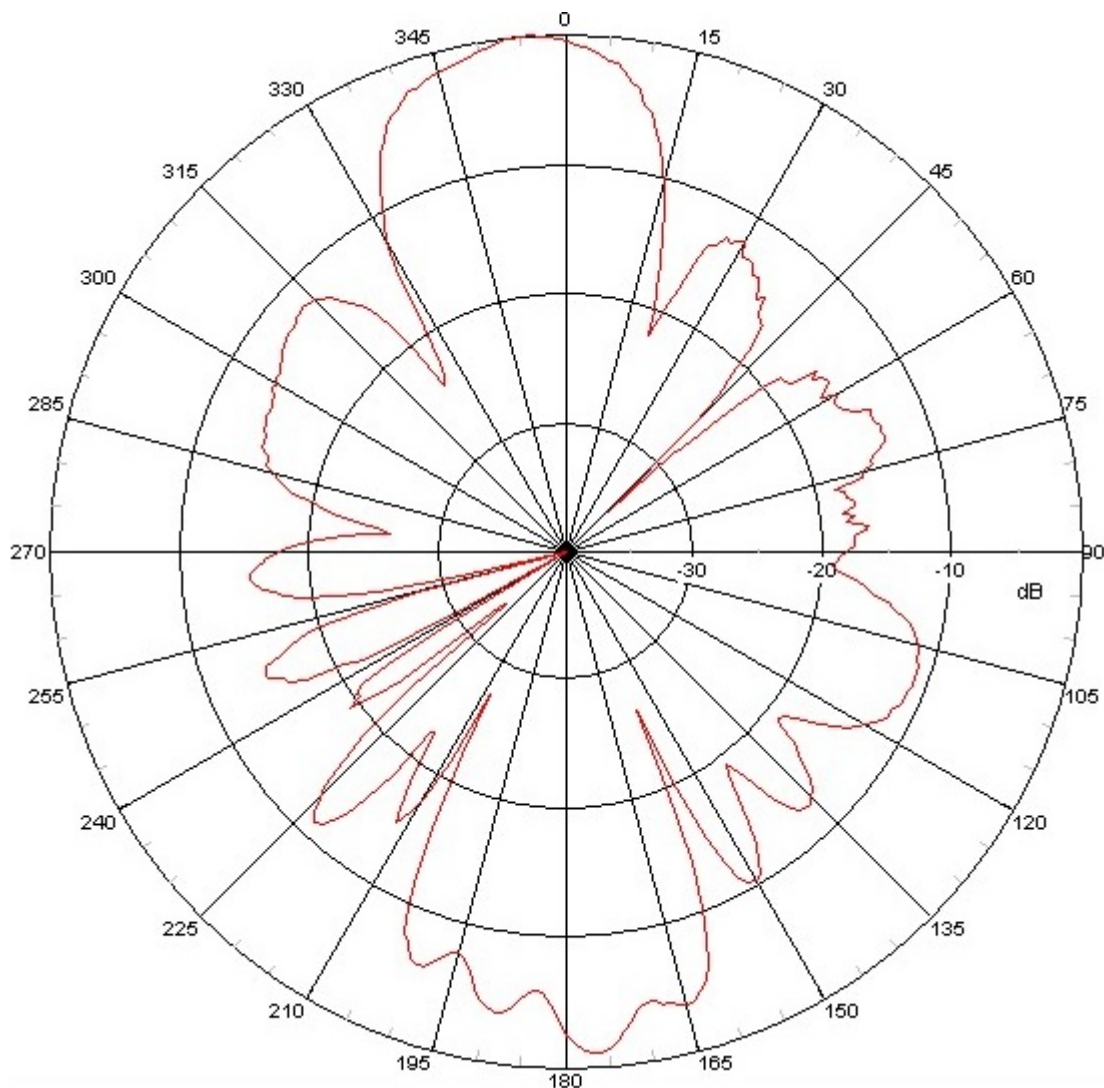

WiMo Antennen und Elektronik GmbH

Am Gäxwald 14, D-76863 Herxheim Tel. (07276) 9668-0 FAX 9668-11

<http://www.wimo.com>

e-mail: info@wimo.com